

→ REDUCING ELBOW HOSE CONNECTOR

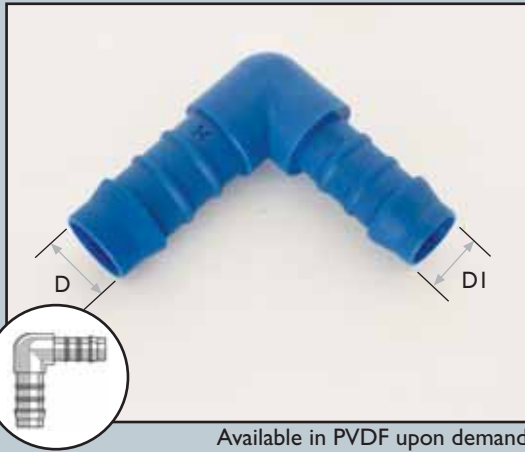

Available in PVDF upon demand

CAT. NO.	D Hose I.D	DI Hose I.D	Color
I2446645448	5 mm	4 mm	Blue
I2446646458	6 mm	5 mm	
I2446648468	8 mm	6 mm	
I2446650468	10 mm	6 mm	
I2446650488	10 mm	8 mm	
I2446652508	12 mm	10 mm	
I2446654528	14 mm	12 mm	
I2446656548	16 mm	14 mm	
I2446659568	19 mm	16 mm	
I2256603023	3/16"	5/32"	Grey
I2256604033	1/4"	3/16"	
I2256605043	5/16"	1/4"	
I2256606043	3/8"	1/4"	
I2256606053	3/8"	5/16"	
I2256608063	1/2"	3/8"	
I2256609083	9/16"	1/2"	
I2256610093	5/8"	9/16"	
I2256612103	3/4"	5/8"	

→ ELBOW HOSE CONNECTOR

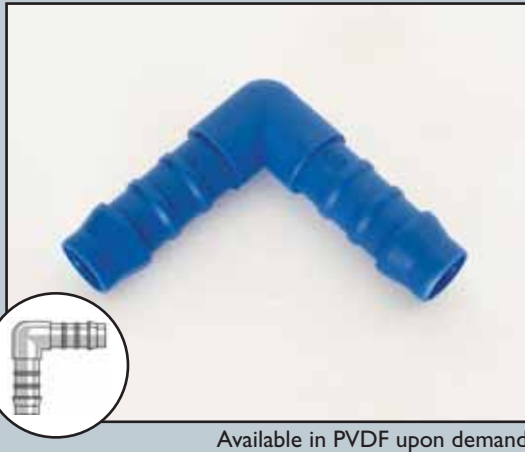

Available in PVDF upon demand

CAT. NO.	Hose I.D	Color
I2446544008	4 mm	Blue
I2446545008	5 mm	
I2446546008	6 mm	
I2446548008	8 mm	
I2446550008	10 mm	
I2446552008	12 mm	
I2446554008	14 mm	
I2446556008	16 mm	
I2446559008	19 mm	
I2256502003	5/32"	Grey
I2256503003	3/16"	
I2256504003	1/4"	
I2256505003	5/16"	
I2256506003	3/8"	
I2256508003	1/2"	
I2256509003	9/16"	
I2256510003	5/8"	
I2256512003	3/4"	

→ REDUCING HOSE CONNECTOR

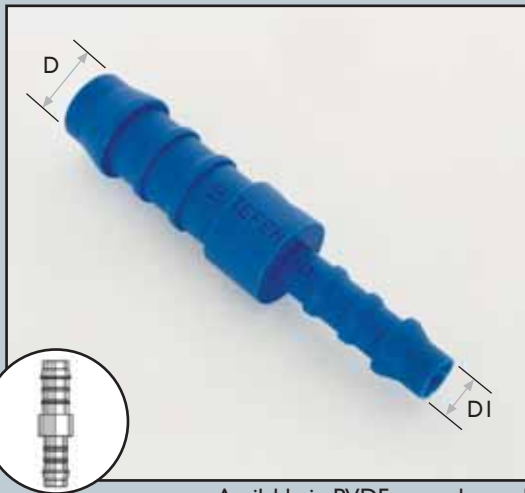

Available in PVDF upon demand

CAT. NO.	D Hose I.D	DI Hose I.D	Color
I2445645448	5 mm	4 mm	Blue
I2445646448	6 mm	4 mm	
I2445646458	6 mm	5 mm	
I2445648458	8 mm	5 mm	
I2445648468	8 mm	6 mm	
I2445650468	10 mm	6 mm	
I2445650488	10 mm	8 mm	
I2445652488	12 mm	8 mm	
I2445652508	12 mm	10 mm	
I2445654508	14 mm	10 mm	
I2445654528	14 mm	12 mm	
I2445656528	16 mm	12 mm	
I2445656548	16 mm	14 mm	
I2445659548	19 mm	14 mm	
I2445659568	19 mm	16 mm	
I2255603023	3/16"	5/32"	
I2255604023	1/4"	5/32"	
I2255604033	1/4"	3/16"	
I2255605033	5/16"	3/16"	
I2255605043	5/16"	1/4"	
I2255606043	3/8"	1/4"	
I2255606053	3/8"	5/16"	
I2255608053	1/2"	5/16"	
I2255608063	1/2"	3/8"	
I2255609063	9/16"	3/8"	
I2255609083	9/16"	1/2"	
I2255610083	5/8"	1/2"	
I2255610093	5/8"	9/16"	
I2255612093	3/4"	9/16"	
I2255612103	3/4"	5/8"	

→ HOSE CONNECTOR

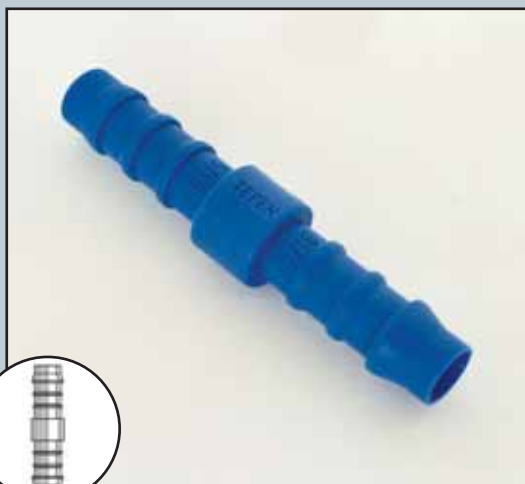

Available in PVDF upon demand

CAT. NO.	Hose I.D	Color
I2446244008	4 mm	
I2446245008	5 mm	
I2446246008	6 mm	
I2446248008	8 mm	
I2446250008	10 mm	
I2446252008	12 mm	
I2446254008	14 mm	
I2446256008	16 mm	
I2446259008	19 mm	
I2256202003	5/32"	
I2256203003	3/16"	
I2256204003	1/4"	
I2256205003	5/16"	
I2256206003	3/8"	
I2256208003	1/2"	
I2256209003	9/16"	
I2256210003	5/8"	
I2256211003	11/16"	
I2256212003	3/4"	

→ Y HOSE CONNECTOR



CAT. NO.	Hose I.D	Color
I2446344448	4 mm	
I2446346468	6 mm	
I2446348488	8 mm	
I2446350508	10 mm	
I2446357578	17 mm	
I2256302023	5/32"	
I2256304043	1/4"	
I2256305053	5/16"	
I2256306063	3/8"	
I2256311113	11/16"	

→ UNION T HOSE CONNECTOR



Available in PVDF upon demand

CAT. NO.	Hose I.D	Color
I2446444448	4 mm	
I2446445458	5 mm	
I2446446468	6 mm	
I2446448488	8 mm	
I2446450508	10 mm	
I2446452528	12 mm	
I2446454548	14 mm	
I2446456568	16 mm	
I2446459598	19 mm	
I2256402023	5/32"	
I2256403033	3/16"	
I2256404043	1/4"	
I2256405053	5/16"	
I2256406063	3/8"	
I2256408083	1/2"	
I2256409093	9/16"	
I2256410103	5/8"	
I2256412123	3/4"	

→ OD-Outer diameter → SW-Standard Wrench
→ ID-Inner diameter → R-Radius

→ MALE BRANCH T HOSE CONNECTOR

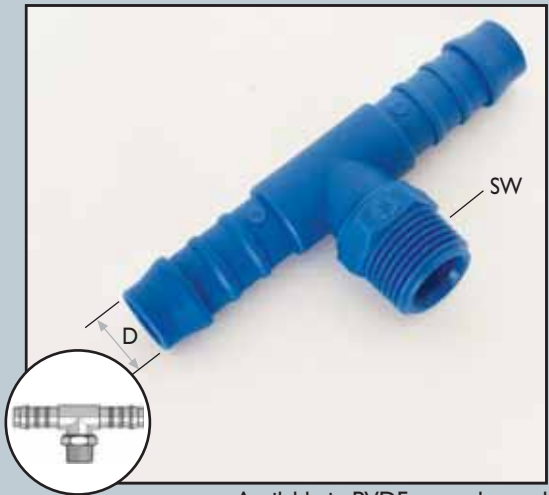

Available in PVDF upon demand

CAT. NO.	D Hose I.D	Thread BSPT	SW mm	Color
I2447144028	4 mm	1/8"	11	
I2447144048	4 mm	1/4"	14	
I2447145028	5 mm	1/8"	11	
I2447145048	5 mm	1/4"	14	
I2447146028	6 mm	1/8"	11	
I2447146048	6 mm	1/4"	14	
I2447146068	6 mm	3/8"	17	
I2447146088	6 mm	1/2"	22	
I2447148028	8 mm	1/8"	11	
I2447148048	8 mm	1/4"	14	
I2447148068	8 mm	3/8"	17	
I2447148088	8 mm	1/2"	22	
I2447150048	10 mm	1/4"	14	
I2447150068	10 mm	3/8"	17	
I2447150088	10 mm	1/2"	22	
I2447150128	10 mm	3/4"	27	
I2447152048	12 mm	1/4"	14	
I2447152068	12 mm	3/8"	17	
I2447152088	12 mm	1/2"	22	
I2447152128	12 mm	3/4"	27	
I2447154068	14 mm	3/8"	17	
I2447154088	14 mm	1/2"	22	
I2447154128	14 mm	3/4"	27	
I2447156088	16 mm	1/2"	22	
I2447156128	16 mm	3/4"	27	
I2447159088	19 mm	1/2"	22	
I2447159128	19 mm	3/4"	27	

→ FLANGE BRANCH T HOSE CONNECTOR



Available in PVDF upon demand

CAT. NO.	D Hose I.D	Thread NPT	SW mm	Color
I2257102023	5/32"	1/8"	11	
I2257102043	5/32"	1/4"	14.5	
I2257103023	3/16"	1/8"	11	
I2257103043	3/16"	1/4"	14.5	
I2257103083	3/16"	1/2"	24	
I2257104023	1/4"	1/8"	11	
I2257104043	1/4"	1/4"	14.5	
I2257104063	1/4"	3/8"	18	
I2257104083	1/4"	1/2"	24	
I2257105023	5/16"	1/8"	11	
I2257105043	5/16"	1/4"	14.5	
I2257105063	5/16"	3/8"	18	
I2257105083	5/16"	1/2"	24	
I2257106043	3/8"	1/4"	14.5	
I2257106063	3/8"	3/8"	18	
I2257106083	3/8"	1/2"	24	
I2257106123	3/8"	3/4"	27	
I2257108043	1/2"	1/4"	14.5	
I2257108063	1/2"	3/8"	18	
I2257108083	1/2"	1/2"	24	
I2257108123	1/2"	3/4"	27	
I2257109063	9/16"	3/8"	18	
I2257109083	9/16"	1/2"	24	
I2257109123	9/16"	3/4"	27	
I2257110083	5/8"	1/2"	24	
I2257110123	5/8"	3/4"	27	
I2257112083	3/4"	1/2"	24	
I2257112123	3/4"	3/4"	27	

CAT. NO.	D Hose I.D	Thread BSPT	SW mm	Color
I2F47150068	10 mm	3/8"	17	
I2F47150088	10 mm	1/2"	22	

→ OD-Outer diameter → SW-Standard Wrench
→ ID-Inner diameter → R-Radius

→ REDUCING T HOSE CONNECTOR

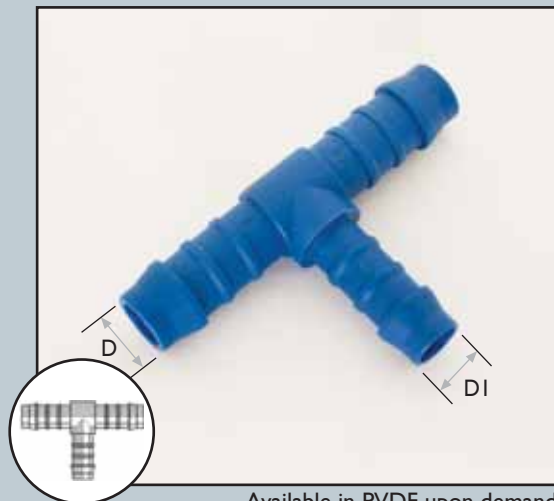

Available in PVDF upon demand

CAT. NO.	D Hose I.D	DI Hose I.D	Color
12447245448	5 mm	4 mm	
12447246458	6 mm	5 mm	
12447248468	8 mm	6 mm	
12447250488	10 mm	8 mm	
12447252508	12 mm	10 mm	
12447254528	14 mm	12 mm	
12447256548	16 mm	14 mm	
12447259568	19 mm	16 mm	
12257203023	3/16"	5/32"	
12257204033	1/4"	3/16"	
12257205043	5/16"	1/4"	
12257206053	3/8"	5/16"	
12257208063	1/2"	3/8"	
12257209083	9/16"	1/2"	
12257210093	5/8"	9/16"	
12257212103	3/4"	5/8"	

→ FEMALE SWIVEL STRAIGHT HOSE CONNECTOR - CONICAL SEAT

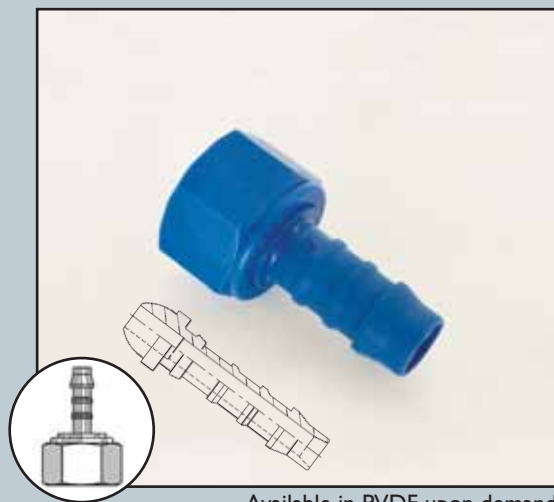

Available in PVDF upon demand

Nylon Swivel connector with conical seat tube dressed onto barbed tail and secured with Tefen snap clip (page 25). Suitable for plastic, rubber and soft P.V.C. hoses. Colour: Blue. Temperature: Max 90°C

CAT. NO.	Hose I.D	Thread BSP	SW mm	Colour
22444644028	4 mm	1/8"	13	
22444645028	5 mm	1/8"	13	
22444644048	4 mm	1/4"	16	
22444645048	5 mm	1/4"	16	
22444646048	6 mm	1/4"	16	
22444648048	8 mm	1/4"	16	
22444645068	5 mm	3/8"	20	
22444646068	6 mm	3/8"	20	
22444648068	8 mm	3/8"	20	
22444650068	10 mm	3/8"	20	
22444646088	6 mm	1/2"	24	
22444648088	8 mm	1/2"	24	
22444650088	10 mm	1/2"	24	
22444652088	12 mm	1/2"	24	
22444654088	14 mm	1/2"	24	
22444648128	8 mm	3/4"	30	
22444650128	10 mm	3/4"	30	
22444652128	12 mm	3/4"	30	
22444654128	14 mm	3/4"	30	
22444656128	16 mm	3/4"	30	
22444659128	19 mm	3/4"	30	
22444648042	8 mm	1/4"	16	
22444650062	10 mm	3/8"	20	
22444652082	12 mm	1/2"	24	

→ FEMALE SWIVEL STRAIGHT HOSE CONNECTOR



Available in PVDF upon demand

CAT. NO.	Hose I.D.	Thread BSP	SW mm
22454765168	24 mm	1"	44

→ FLANGE PIPE ELBOW

CAT. NO.	Thread BSPT	SW mm
12016506L08	3/8"	12

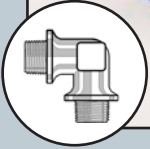

Available in PVDF upon demand

→ SNAP CLIP ACETAL



CAT. NO.	R	D mm
17090010002	R-8	8-10
17090012002	R-10	10-12
17090013002	R-11	11-13
17090015002	R-13	13-15
17090016002	R-14	14-16
17090017002	R-15	15-17
17090018002	R-16	16-18
17090019002	R-17	17-19
17090020002	R-18	18-20
17090021002	R-20	20-22
17090023002	R-21	21-23
17090025002	R-23	23-25
17090028002	R-26	26-28
17090032002	R-30	30-32
17090037002	R-35	35-37
17090046002	R-44	44-46
17090049002	R-47	47-49

SNAP CLIP

Material: Acetal resin
 Colour: Black.
 Working pressure: Up to 14 BAR (200 psi).
 Temperature: -4°C + 90°C (after fitting).
 Assembly: With hose in place locate snap clip around the hose and simple manual pressure will ensure a snug joint. Use plier to tighten. Release by applying lateral pressure.
 Advantages: Strong and durable. Reusable.



→ OD-Outer diameter → SW-Standard Wrench
 → ID-Inner diameter → R-Radius

ADAPTORS



Material: Nylon 66.
 Colour: Blue.
 Working pressure: Up to 14 BAR (200 psi).



Temperature: -20°C +110°C (subject to application).
 These fittings are supplementary to all other fittings enabling various adapting combinations.

→ **PANEL MOUNTING NUT**

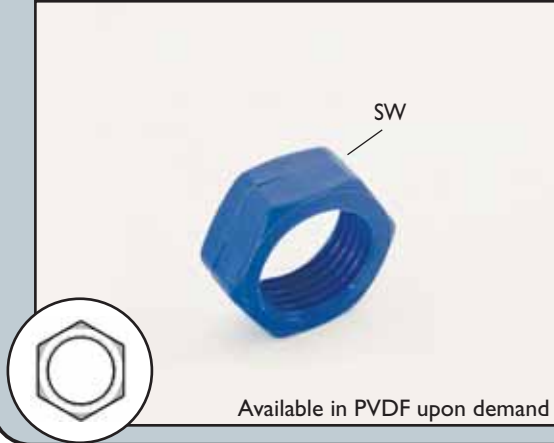

CAT. NO.	Colour	Thread BSPT	SW mm
32006100042	Black	1/4"	15
32006100081	White (thin)	1/2"	25.5
32006100082	Black	1/2"	25.5
32006100088	Blue	M20	Ø 28
32006100201	White	1/2"	25.5

→ **PIPE REDUCING NIPPLE**



CAT. NO.	R Thread BSPT	RI Thread BSPT	SW mm	Color
I2012304028	1/4"	1/8"	17	Blue
I2012306028	3/8"	1/8"	19	Blue
I2012306048	3/8"	1/4"	19	Blue
I2012308048	1/2"	1/4"	22	Blue
I2012308068	1/2"	3/8"	22	Blue

CAT. NO.	R Thread NPT	RI Thread NPT	SW mm	Color
I2022304023	1/4"	1/8"	14.5	Grey
I2022306023	3/8"	1/8"	17.5	Grey
I2022308023	1/2"	1/8"	22	Grey
I2022312023	3/4"	1/8"	27	Grey
I2022306043	3/8"	1/4"	17.5	Grey
I2022308043	1/2"	1/4"	22	Grey
I2022312043	3/4"	1/4"	27	Grey
I2022308063	1/2"	3/8"	22	Grey
I2022312063	3/4"	3/8"	27	Grey
I2022312083	3/4"	1/2"	27	Grey

→ **PIPE HEX NIPPLE**



CAT. NO.	Thread BSPT	SW mm	Color
I2012202028	1/8"	14	Blue
I2012204048	1/4"	17	Blue
I2012206068	3/8"	19	Blue
I2012208088	1/2"	22	Blue

CAT. NO.	Thread NPT	SW mm	Color
I2022202023	1/8"	11	Grey
I2022204043	1/4"	14.5	Grey
I2022206063	3/8"	17.5	Grey
I2022208083	1/2"	22	Grey
I2022212123	3/4"	27	Grey

→ OD-Outer diameter → SW-Standard Wrench
 → ID-Inner diameter → R-Radius

→ P I P E A D A P T O R

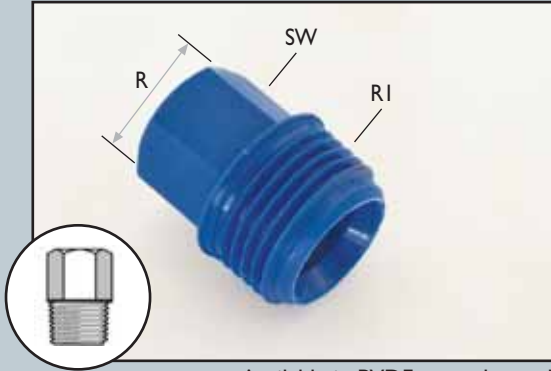

Available in PVDF upon demand

CAT. NO.	R Thread BSPT	RI Thread BSPT	SW mm	Color
I2012002028	1/8"	1/8"	14	
I2012002048	1/8"	1/4"	14	
I2012002068	1/8"	3/8"	14	
I2012002088	1/8"	1/2"	14	
I2012004028	1/4"	1/8"	17	
I2012004048	1/4"	1/4"	17	
I2012004068	1/4"	3/8"	17	
I2012004088	1/4"	1/2"	17	
I2012006028	3/8"	1/8"	22	
I2012006048	3/8"	1/4"	22	
I2012006068	3/8"	3/8"	22	
I2012006088	3/8"	1/2"	22	
I2012008028	1/2"	1/8"	26	
I2012008048	1/2"	1/4"	26	
I2012008068	1/2"	3/8"	26	
I2012008088	1/2"	1/2"	26	

CAT. NO.	R Thread NPT	RI Thread NPT	SW mm	Color
I2022002023	1/8"	1/8"	14	
I2022002043	1/8"	1/4"	14	
I2022002063	1/8"	3/8"	14	
I2022002083	1/8"	1/2"	14	
I2022004023	1/4"	1/8"	17	
I2022004043	1/4"	1/4"	17	
I2022004063	1/4"	3/8"	17	
I2022004083	1/4"	1/2"	17	
I2022006023	3/8"	1/8"	22	
I2022006043	3/8"	1/4"	22	
I2022006063	3/8"	3/8"	22	
I2022006083	3/8"	1/2"	22	
I2022008023	1/2"	1/8"	26	
I2022008043	1/2"	1/4"	26	
I2022008063	1/2"	3/8"	26	
I2022008083	1/2"	1/2"	26	

→ P I P E B U S H I N G

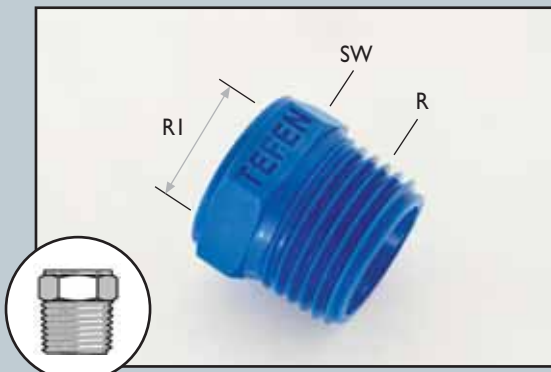

Available in PVDF upon demand

CAT. NO.	R Thread BSPT	RI Thread BSPT	SW mm	Color
I2011004028	1/4"	1/8"	14	
I2011006028	3/8"	1/8"	17	
I2011006048	3/8"	1/4"	17	
I2011008028	1/2"	1/8"	22	
I2011008048	1/2"	1/4"	22	
I2011008068	1/2"	3/8"	22	
I2011012048	3/4"	1/4"	27	
I2011012068	3/4"	3/8"	27	
I2011012088	3/4"	1/2"	27	

CAT. NO.	R Thread NPT	RI Thread NPT	SW mm	Color
I2021004023	1/4"	1/8"	14	
I2021006023	3/8"	1/8"	18.5	
I2021006043	3/8"	1/4"	18.5	
I2021008023	1/2"	1/8"	24	
I2021008043	1/2"	1/4"	24	
I2021008063	1/2"	3/8"	24	
I2021012043	3/4"	1/4"	29	
I2021012063	3/4"	3/8"	29	
I2021012083	3/4"	1/2"	29	

→ OD-Outer diameter → SW-Standard Wrench
→ ID-Inner diameter → R-Radius

→ FEMALE PIPE COUPLING



CAT.NO.	Thread BSPT	SW mm	Colour
I2010302021	1/8"	14	
I2010304042	1/4"	17	
I2010302028	1/8"	14	
I2010304048	1/4"	17	
I2010306068	3/8"	21	
I2010308088	1/2"	26	
I2010312128	3/4"	34	

CAT.NO.	Thread NPT	SW mm	Colour
I2020302023	1/8"	14	
I2020304043	1/4"	17	
I2020306063	3/8"	21	
I2020308083	1/2"	26	

→ THREADED ELBOW



CAT.NO.	Thread BSPT	SW mm	Colour
I2016502002	1/8"	10	
I2016504001	1/4"	10	
I2016504002	1/4"	10	
I2016504007	1/4"	10	
I2016502008	1/8"	10	
I2016504008	1/4"	10	
I2016506008	3/8"	14	
I2016508008	1/2"	17	

CAT.NO.	Thread NPT	SW mm	Colour
I2026502003	1/8"	10	
I2026504003	1/4"	10	

→ THREADED REDUCING ELBOW



CAT.NO.	RThread BSPT	RI Thread BSPT	SW mm	Color
I2016904028	1/4"	1/8"	10	
I2016906048	3/8"	1/4"	15	
I2016908068	1/2"	3/8"	17	

CAT.NO.	RThread NPT	RI Thread NPT	SW mm	Color
I2026904023	1/4"	1/8"	10	

→ HEX THREADED PLUG

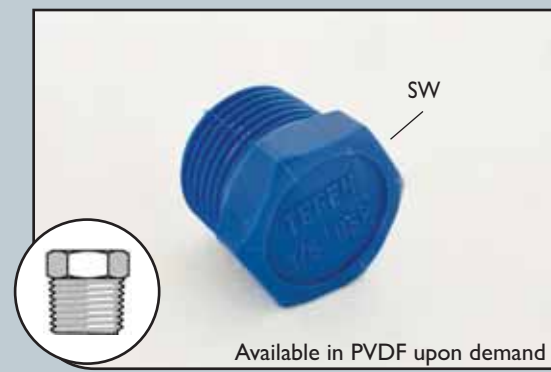

CAT.NO.	Thread BSPT	SW mm	Color
I2012104001	1/4"	15	
I2012104002	1/4"	15	
I2012102008	1/8"	12	
I2012104008	1/4"	15	
I2012106008	3/8"	17	
I2012108008	1/2"	22	
I2012112008	3/4"	30	
I2012116008	1"	36	

CAT.NO.	Thread NPT	SW mm	Color
I2022102003	1/8"	12	
I2022104003	1/4"	14	
I2022106003	3/8"	17	
I2022108003	1/2"	22	
I2022112003	3/4"	30	

→ OD-Outer diameter → SW-Standard Wrench
 → ID-Inner diameter → R-Radius

→ HEXTHREADED FLANGE PLUG



Available in PVDF upon demand

CAT.NO.	Thread BSPT	SW mm
I2012108L08	1/2"	22

→ P I P E C A P

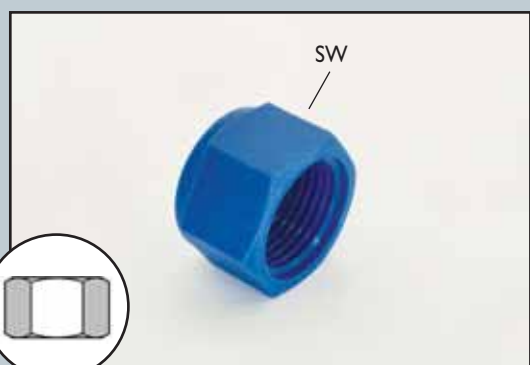

Available in PVDF upon demand

CAT.NO.	Thread BSPT	SW mm	Color
I2010802008	1/8"	13	
I2010804008	1/4"	16	
I2010806008	3/8"	20	
I2010808008	1/2"	25	
I2010812008	3/4"	30	

→ PIPE REDUCING COUPLING

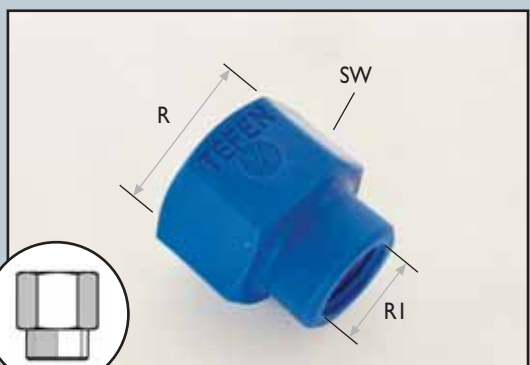

Available in PVDF upon demand

CAT.NO.	RThread BSPT	RI Thread BSPT	SW mm	Color
I2011904028	1/4"	1/8"	17	
I2011906028	3/8"	1/8"	21	
I2011906048	3/8"	1/4"	21	
I2011908048	1/2"	1/4"	26	
I2011908068	1/2"	3/8"	26	
I2011912048	3/4"	1/4"	30	
I2011912088	3/4"	1/2"	30	

CAT.NO.	RThread NPT	RI Thread NPT	SW mm	Color
I2021904023	1/4"	1/8"	17	
I2021906023	3/8"	1/8"	21	
I2021906043	3/8"	1/4"	21	
I2021908043	1/2"	1/4"	26	
I2021908063	1/2"	3/8"	26	

→ OD-Outer diameter → SW-Standard Wrench
→ ID-Inner diameter → R-Radius

→ P I P E T

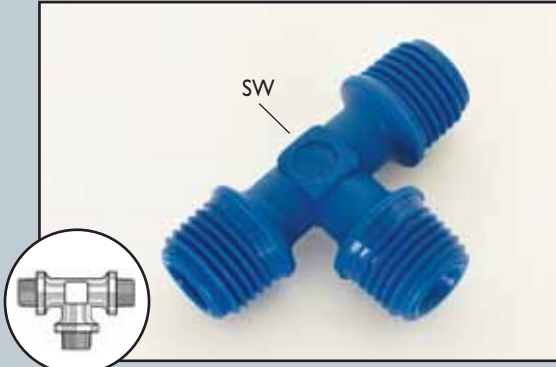

Available in PVDF upon demand

CAT. NO.	Thread BSPT	SW mm	Color
I2016402008	1/8"	12	Blue
I2016404008	1/4"	12	
I2016406008	3/8"	15	
I2016408008	1/2"	17	
CAT. NO.	Thread NPT	SW mm	Color
I2026402003	1/8"	12	Grey
I2026404003	1/4"	12	

→ PIPE REDUCING BRANCH T



Available in PVDF upon demand

CAT. NO.	R Thread BSPT	RI Thread BSPT	SW mm	Color
I2017104028	1/4"	1/8"	14	Blue
I2017106048	3/8"	1/4"	14	
I2017108068	1/2"	3/8"	14	
I2017102048	1/8"	1/4"	14	
I2017104068	1/4"	3/8"	17	
I2017106088	3/8"	1/2"	17	
CAT. NO.	R Thread NPT	RI Thread NPT	SW mm	Color
I2027104023	1/4"	1/8"	12	Grey

→ PIPE REDUCING RUN T



Available in PVDF upon demand

CAT. NO.	R Thread BSPT	RI Thread BSPT	SW mm	Color
I2017204028	1/4"	1/8"	12	Blue
I2017206048	3/8"	1/4"	15	
I2017208068	1/2"	3/8"	17	
I2017202048	1/8"	1/4"	12	
I2017204068	1/4"	3/8"	15	
I2017206088	3/8"	1/2"	17	
CAT. NO.	R Thread NPT	RI Thread NPT	SW mm	Color
I2027204023	1/4"	1/8"	12	Grey

→ OD-Outer diameter → SW-Standard Wrench
→ ID-Inner diameter → R-Radius

QUICK CONNECTOR

Material: Acetal resin, stainless steel spring. Sealed by NBR "O" ring.

Colour: Black and Red.

 Working pressure: Up to 14 BAR (200 psi).

 Temperature: -20°C +110°C (subject to application).

This small quick connector has easily movable sleeve that locks the plug in place. When the plug is disconnected the socket acts as shut off valve.
Uses: In air and water lines.

→ QUICK RELEASE SOCKET

CAT. NO.	Thread BSPT	SW mm
* 22080004000	1/4"	19
** 22081104002	1/4"	19



* The body is made of Nylon.

** With viton seal.

→ PLUG - EXTERNAL THREAD

CAT. NO.	Thread BSPT	SW mm
12081404006	1/4"	17

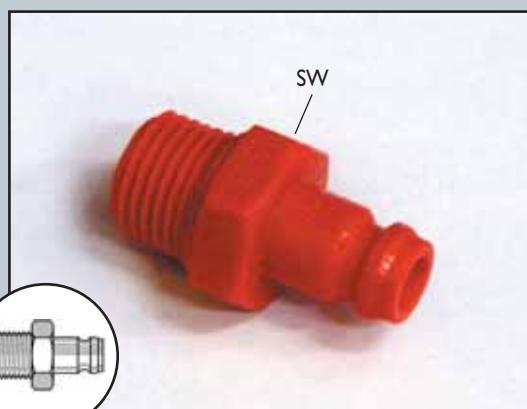

→ PLUG - INTERNAL THREAD

CAT. NO.	Thread BSPT	SW mm
12081504006	1/4"	17

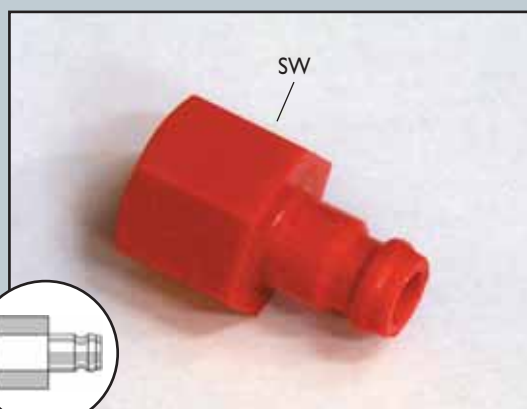

→ PLUG - HOSE CONNECTOR

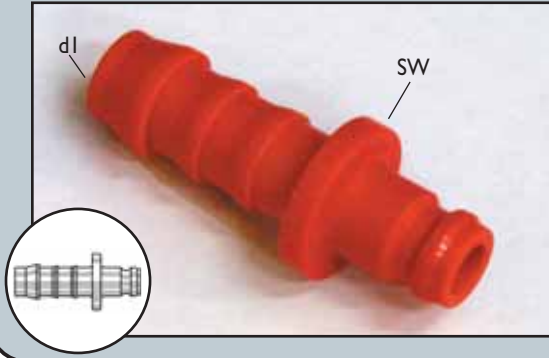

CAT.NO.	d-Tube I.D	SW mm
12081645006	5 mm	17
12081646006	6 mm	17
12081648006	8 mm	17
12081650006	10 mm	17
12081652006	12 mm	17

→ VALVE 1 / 4 "

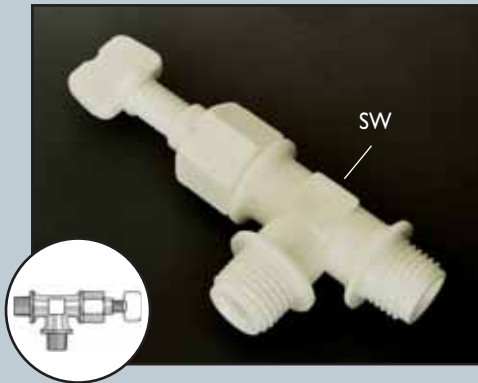

CAT.NO.	Thread BSPT
22272904011	1/4"
22272904012	1/4"
22272904017	1/4"

Material:Acetal.
This needle valve is used for controlling small quantities of water in indoor applications.

→ SILENCER WITH RESTRICTOR VALVE FOR PNEUMATIC VALVES

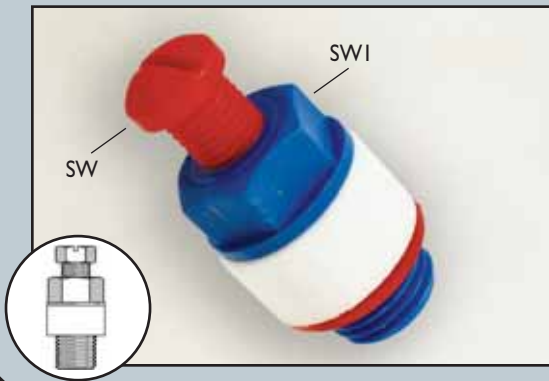

CAT.NO.	Thread BSPT	SW mm	SW1 mm
PLASTIC SCREW			
22276004000	1/4"	15	13
22276008000	1/2"	25	18
BRASS SCREW			
22276004010	1/4"	15	13
22276008010	1/2"	25	18

This combined silencer and restrictor valve unit provides cylinder speed adjustment and noise reduction. Silencer is generally inserted in air outlet of cylinder control valve.

→ VALVE RELEASE / DRAIN VALVE



CAT.NO.	Thread BSPT
22273008002	1/2"
22273108002	1/2"

Valve Vacuum release

Valve installed vertically upwards on the highest point. Functions as antisiphon valve (CAT.No.22273008002).

Drain Valve with stainless spring

Valve installed at pipe end. For automatic drainage of condensed water in compressed-air lines, after shut-off of compressed-air supply. (CAT.No.22273108002)

→ LDPE

→ LDPE CONTROLTUBES



CAT.NO.	O.D	I.D	Min bend radius	Roll Length
I403000450X	1/4"	0.170"	1"	500 m
I403004601X	6 mm	4 mm	1"	100 m
I403004620X	6 mm	4 mm	1"	200 m
I403004650X	6 mm	4 mm	1"	500 m
I403004810X	8 mm	5.6 mm	1 1/2"	100 m
I403004820X	8 mm	5.6 mm	1 1/2"	200 m
I403004850X	8 mm	5.6 mm	1 1/2"	500 m

Available to order between 1 to 4 stripes (in the same color)
Standard 2 stripes

Standard packaging for all tubes →



Drum packaging available for 500 m rolls →



→ LDPE TUBES



CAT.NO.	O.D	I.D	Min bend radius	Roll Length
I403000310X	3/16"	0.117"	1/2"	100 m
I403000410X	1/4"	0.170"	1"	100 m
I403000510X	5/16"	0.212"	1 1/2"	100 m
I403000610X	3/8"	0.256"	2"	100 m
I403000810X	1/2"	0.381"	3"	100 m
I403004410X	4 mm	2.2 mm	12 mm	100 m
I403004610X	6 mm	4 mm	25 mm	100 m
I403000510X	8 mm	5.3 mm	35 mm	100 m
I403005010X	10 mm	7 mm	50 mm	100 m
I403005210X	12 mm	9 mm	75 mm	100 m

Standard packaging for all tubes →



Recommended Work Pressure For All PETubes At 20 ° is 10 Bar (147 PSI): Class (rank) 10

Recommended nominal working pressure for LDPE

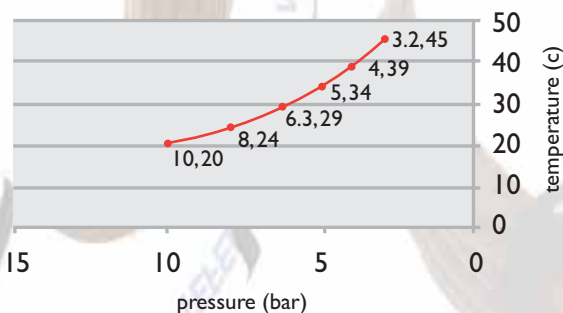

COLOR CODING:

LDPE control tubes: X stands for the color of the added stripes (basic color of the tube is black).

LDPE tubes: X stands for the color of the tube.

- 1 White
- 2 Black
- 6 Red
- 7 Green
- 8 Blue
- 9 Yellow

→ HDPE

→ HDPE PN-16		CAT. NO.	O.D	W.T.	Nominal Pressure Bar (PSI)	Min Band Radius	Packing
		I402004610X	6.00 mm	0.8 mm	16 (235.2)	30 mm	100 M
		I402004620X	6.00 mm	0.8 mm	16 (235.2)	30 mm	200 M
		I402004650X	6.00 mm	0.8 mm	16 (235.2)	30 mm	500 M
		I402000410X	1/4" (6.35 mm)	1/32" (0.8 mm)	16 (235.2)	1.25"	100 M
		I402000420X	1/4" (6.35 mm)	1/32" (0.8 mm)	16 (235.2)	1.25"	200 M
		I402000450X	1/4" (6.35 mm)	1/32" (0.8 mm)	16 (235.2)	1.25"	500 M
		I402004810X	8.00 mm	1.00 mm	16 (235.2)	40 mm	100 M
		I402004820X	8.00 mm	1.00 mm	16 (235.2)	40 mm	200 M
		I402004850X	8.00 mm	1.00 mm	16 (235.2)	40 mm	500 M
		I402000510X	5/16" (8.00 mm)	0.039" (1.00 mm)	16 (235.2)	1.6"	100 M
		I402000520X	5/16" (8.00 mm)	0.039" (1.00 mm)	16 (235.2)	1.6"	200 M
		I402000550X	5/16" (8.00 mm)	0.039" (1.00 mm)	16 (235.2)	1.6"	500 M





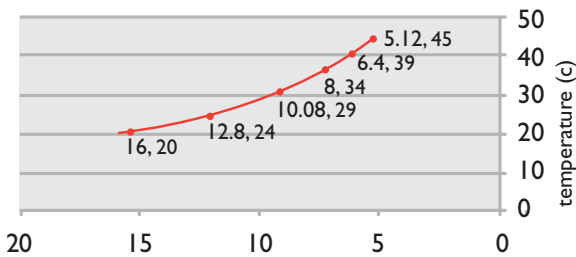

The recommended maximum working pressure at 20° is 16 Bar (235.2 PSI): Class (rank) 16

Recommended nominal working pressure for HDPE

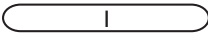

HDPE COLOR CODING:

HDPE tubes: X stands for the color of the tube.



-  1 White
-  2 Black
-  6 Red
-  7 Green
-  8 Blue
-  9 Yellow

→ HDPE PN-24		CAT. NO.	O.D	W.T.	Nominal Pressure Bar (PSI)	Min Band Radius	Packing
		I4010046102	6.00 mm	0.8 mm	24 (353)	30 mm	100 M
		I4010046202	6.00 mm	0.8 mm	24 (353)	30 mm	200 M
		I4010046502	6.00 mm	0.8 mm	24 (353)	30 mm	500 M
		I4010004102	1/4" (6.35 mm)	0.035" (0.9 mm)	24 (353)	1.25"	100 M
		I4010004202	1/4" (6.35 mm)	0.035" (0.9 mm)	24 (353)	1.25"	200 M
		I4010004502	1/4" (6.35 mm)	0.035" (0.9 mm)	24 (353)	1.25"	500 M
		I4010048102	8.00 mm	1.00 mm	24 (353)	40 mm	100 M
		I4010048202	8.00 mm	1.00 mm	24 (353)	40 mm	200 M
		I4010048502	8.00 mm	1.00 mm	24 (353)	40 mm	500 M
		I4010005102	5/16" (8.00 mm)	0.039" (1.00 mm)	24 (353)	1.6"	100 M
		I4010005202	5/16" (8.00 mm)	0.039" (1.00 mm)	24 (353)	1.6"	200 M
		I4010005502	5/16" (8.00 mm)	0.039" (1.00 mm)	24 (353)	1.6"	500 M

The recommended maximum working pressure at 20° is 24 Bar (353 PSI): Class (rank) 24

→ PVC

→ PLASTICIZED PVC TUBES		CAT. NO.	O.D	I.D	Roll Length
		I407000510X	5 mm	3 mm	100 m
		I407000520X	5 mm	3 mm	200 m
		I407000525X	5 mm	3 mm	250 m
		I407000550X	5 mm	3 mm	500 m
		I407000505X	5 mm	3 mm	50 m
		I407006510X	6.5 mm	4 mm	100 m
		I407006520X	6.5 mm	4 mm	200 m
		I407000710X	7 mm	4 mm	100 m
		I407000720X	7 mm	4 mm	200 m
		I407000725X	7 mm	4 mm	250 m
		I407000750X	7 mm	4 mm	500 m
		I407464905X	9 mm	6 mm	50 m
		I407001020X	10 mm	7 mm	100 m
		I407001220X	12 mm	7 mm	100 m
		I407001310X	13 mm	9 mm	100 m
		I407001610X	16 mm	11 mm	100 m

Standard PVC tubes are black 
 Also available in transparent 
 or brown 

→ **Air Blow Gun**
with a general purpose nozzle



1/4" female cat No. 22200004022
1 1/16" male cat No. 22200011052

→ **Air Blow Gun**
with an osha regulation safety nozzle



1/4" female cat No. 22200004012
1 1/16" male cat No. 22200011082

→ **Air Blow Gun**
with an air screen nozzle to deflect
flying chips away from operator



1/4" female cat No. 22200004032
1 1/16" male cat No. 22200011062

→ **Air Blow Gun Mark II**



cat No. 22240000060 with 6 mm nozzle
cat No. 22240000080 with 8 mm nozzle
available only with minimum order

→ **Air Blow Gun**
with a restriction nozzle to regulate
output air volume



1/4" female cat No. 22200004042
1 1/16" male cat No. 22200011072

→ **Air Blow Gun Mark III**



cat No. 22230000000

→ Mini Air Blow Gun



cat No. 22190000012 with on osha regulation safety nozzle
cat No. 22190000002

→ 8 mm Nylon Retractable Coil



cat No. 24050505058-5 feet
cat No. 24050505108-10 feet
cat No. 24050505158-15 feet

→ Spray Gun



1/4" female cat No. 22210004002
1 1/16" male cat No. 22210011003

→ Short Spray Gun



1/4" female cat No. 22210004004 IODINE

→ Fine Spray

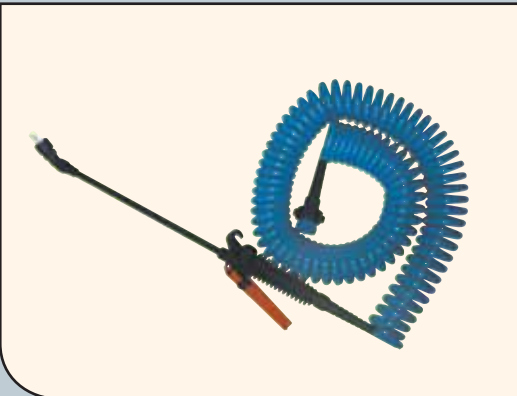

Female end connector
3/4" cat No. 22210512488
1/2" cat No. 22210508488



→ FAN SPRAY NOZZLES



CAT.NO.	Marking	Angle	Color	Lit/Min Bar 2	Lit/Min Bar 3	Lit/Min Bar 4	Lit/Min Bar 6
12210110057	110 005	110°	Green	0.296	0.362	0.417	0.513
12210110209	110 02	110°	Yellow	1.20	1.45	1.70	2.00
12210110255	110 025	110°	White	0.623	0.780	0.899	1.106
12210110308	110 03	110°	Blue	1.167	1.432	1.649	2.039
12210110406	110 04	110°	Red	1.434	1.760	2.032	2.501
12210110503	110 05	110°	Dark Red	1.627	2.027	2.350	2.893
12210165051	65 005	65°	White	0.38	0.47	0.53	0.66
12210165052	65 005	65°	Black	0.38	0.47	0.53	0.66

→ CONICAL SPRAY NOZZLE



CAT.NO.	Marking	Angle	Color	Lit/Min Bar 2	Lit/Min Bar 3	Lit/Min Bar 4	Lit/Min Bar 6
22210011055	1 105	105°	White	0.058	0.068	0.078	0.098
22210011057	1 105	105°	Green	0.058	0.068	0.078	0.098
22210016502	1 65	65°	Grey	0.061	0.074	0.084	0.098
22210018001	1 80	80°	White	0.063	0.078	0.092	0.117
22210018002	1 80	80°	Black	0.063	0.078	0.092	0.117
22210018011	1 80F	80°	White	0.035	0.042	0.049	0.059
22210018012	1 80F	80°	Black	0.035	0.042	0.049	0.059
22210028006	3 80	80°	Red	0.350	0.430	0.520	0.630

→ CONICAL SPRAY NOZZLE 1/8" NPT



CAT.NO.	Marking	Angle	Color	Lit/Min Bar 2	Lit/Min Bar 3	Lit/Min Bar 4	Lit/Min Bar 6
22210211055	21 105	105°	White	0.063	0.075	0.086	0.108
22210218008	21 80	80°	Blue	0.060	0.070	0.080	0.093
22210078001	07 80	80°	White	0.043	0.053	0.060	0.069
22210078002	07 80	80°	Black	0.043	0.053	0.060	0.069
22210078003	07 80	80°	Grey	0.043	0.053	0.060	0.069
22210221202	22 120	120°	Black	0.108	0.132	0.152	0.190
22210078006	07 80F	80°	Red	0.038	0.047	0.054	0.064
22210078011	07 80F	80°	White	0.038	0.047	0.054	0.064
22210078012	07 80F	80°	Black	0.038	0.047	0.054	0.064

→ NON DROP CONICAL SPRAY NOZZLES 1/8" NPT



CAT.NO.	Marking	Angle	Color	Lit/Min Bar 3	Lit/Min Bar 4	Lit/Min Bar 6
22211211052	21 105	105°	Black	0.072	0.084	0.106
22211211055	21 105	105°	White	0.072	0.084	0.106
22211218008	21 80	80°	Blue	0.060	0.074	0.092
22211078001	07 80	80°	White	0.046	0.053	0.069
22211078002	07 80	80°	Black	0.046	0.053	0.069
22211078003	07 80	80°	Grey	0.046	0.053	0.069
22211221202	22 120	120°	Black	0.120	0.142	0.182
22211078006	07 80F	80°	Red	0.040	0.048	0.062
22211078011	07 80F	80°	White	0.040	0.048	0.062
22211078012	07 80F	80°	Black	0.040	0.048	0.062

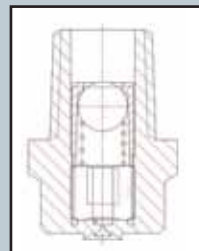

→ CONICAL SPRAY NOZZLE
1/8" NPT WITH FILTER

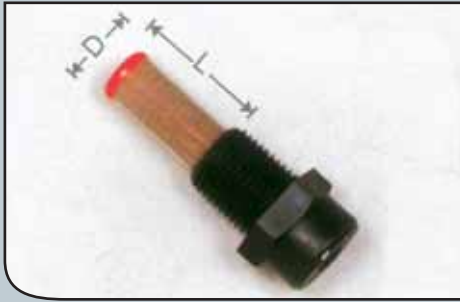

CAT.NO.	Marking	Angle	Color	Lit/Min Bar 2	Lit/Min Bar 3	Lit/Min Bar 4	Lit/Min Bar 6	D	L
22219211055	21 105	105°	White	0.060	0.070	0.080	0.093	7	15
22219218008	21 80	80°	Blue	0.060	0.070	0.080	0.093	7	15
22219078001	07 80	80°	White	0.041	0.050	0.057	0.066	7	15
22219078002	07 80	80°	Black	0.041	0.050	0.057	0.066	7	15
22219078003	07 80	80°	Grey	0.043	0.053	0.060	0.069	7	15
22219221202	22 120	120°	Black	0.103	0.124	0.149	0.171	7	15
22219078006	07 80F	80°	Red	0.040	0.046	0.053	0.061	7	15

The filter is available also in 8 mm length (L)

→ ADJUSTABLE NOZZLE



CAT.NO.22214200001

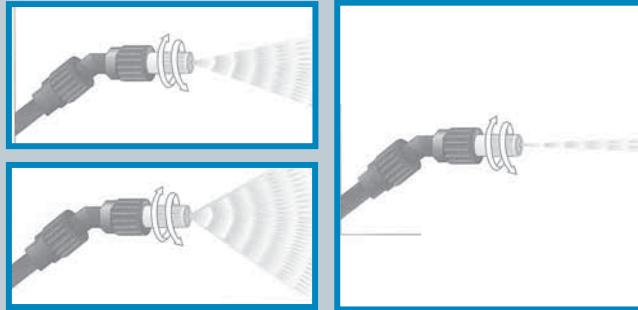

→ NOZZLE FILTERS



CAT.NO.	Mesh	Dmm	SW mm
22212791150	50	10.5	21
22212791100	100	10.5	21
22212791220	200	10.5	21

→ NON DROP NOZZLE FILTERS

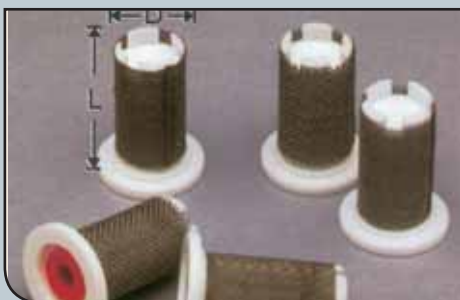

CAT.NO.	Mesh	Dmm	SW mm
22212791050	50	10.5	21
22212791000	100	10.5	21
22212791200	200	10.5	21

→ NUT 1 1/16" FOR NOZZLE

CAT. NO.	R1
32272900082	1 1/16" NC



Also available in white and green

→ 1/4" FEMALE STRAIGHT NOZZLE HOLDER

CAT. NO.	R1	R2
32210300042	1 1/16" NC	1/4" NPT



Also available in white

→ 1/4" MALE STRAIGHT NOZZLE HOLDER

CAT. NO.	R1	R2
32212200042	1 1/16" NC	1/4" NPT



Also available in white

→ 1/4" FEMALE 135° NOZZLE HOLDER

CAT. NO.	R1	R2
32210000040	1 1/16" NC	1/4" NPT



→ PUSH-IN FITTING ADAPTOR FOR 1/8" NOZZLES



CAT. NO.	STEM D	INNER THREAD
22211502061	3/8"	1/8" NPT
22211502062	3/8"	1/8" NPT

→ MISTING UNIT MARK I

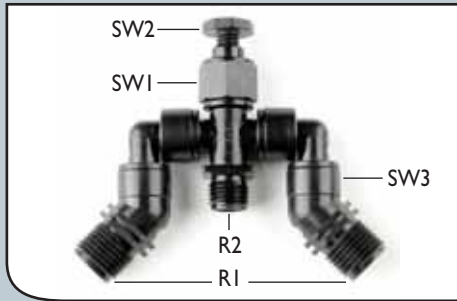

CAT. NO.	R1	R2	SW1	SW2	SW 3	COLOR
22272900101	11/16" NC	1/4" NPT	17.5	16	17.5	
22272900102	11/16" NC	1/4" NPT	17.5	16	17.5	
22272900107	11/16" NC	1/4" NPT	17.5	16	17.5	

→ FINGER FILTER



CAT. NO.	MESH	DIAMETER	LENGTH	I.D.	O.D.
22212002028	100	7 mm	28 mm	1/8" BSPT	1/8" BSPT

→ FINGER FILTER



CAT. NO.	MESH	DIAMETER	LENGTH	I.D.	O.D.
22212791002	100	3/8"	1 7/8"	1/8" Npt	1/4" Npt

→ OD-Outer diameter → SW-Standard Wrench
→ ID-Inner diameter → R-Radius