

TIGHT PUSH FITTINGS

• REDUCING UNION CONNECTOR	2
• UNION CONNECTOR	2
• MALE CONNECTOR	2
• FEMALE CONNECTOR	3
• UNION ELBOW	3
• MALE ELBOW	4
• T CONNECTOR	4
• MALE BRANCH T	5
• MALE RUN T	5

BARB BLOCK FITTINGS

• REDUCING CONNECTOR	6
• UNION CONNECTOR	6
• MALE CONNECTOR	7
• FEMALE CONNECTOR	8
• UNION ELBOW	8
• REDUCING UNION ELBOW	8
• MALE ELBOW	9
• FEMALE ELBOW	9
• MALE BRANCH T	10
• FEMALE BRANCH T	10
• MALE RUN T	11
• UNION T	11
• DOUBLE BANJO BODY	12
• SINGLE BANJO BODY	12
• DOUBLE BANJO BODY BOLT	12
• SINGLE BANJO BODY BOLT	13
• NUT FOR UNION CONNECTORS mm.	13
• NUT FOR UNION CONNECTORS inch	13
• FEMALE UNION SWIVEL CONNECTOR	14
• FEMALE ELBOW SWIVEL CONNECTOR	14
• WATER PRE FILTER	14

AGRICULTURE TUBE FITTINGS

• FEMALE SWIVEL HOSE CONNECTOR WITH WASHER	15
• MALE STRAIGHT HOSE CONNECTOR	15
• UNION HOSE CONNECTOR	15
• REDUCING UNION HOSE CONNECTOR	16
• MALE ELBOW HOSE CONNECTOR	16
• REDUCING ELBOW HOSE CONNECTOR	16
• ELBOW HOSE CONNECTOR	17
• MALE BRANCH T HOSE CONNECTOR	17
• T HOSE CONNECTOR	17
• REDUCING T HOSE CONNECTOR	17

INDUSTRIAL PIPE FITTINGS

• FEMALE THREADED STRAIGHT HOSE CONNECTOR	18
• MALE THREADED STRAIGHT HOSE CONNECTOR	19
• SPECIAL PANEL MALE STRAIGHT HOSE CONNECTOR	19
• FLANGE MOUNTING MALE STRAIGHT HOSE CONNECTOR	19
• MALE THREADED ELBOW HOSE CONNECTOR	20
• MALE THREADED ELBOW HOSE CONNECTOR - FLANGE	20
• REDUCING ELBOW HOSE CONNECTOR	21
• ELBOW HOSE CONNECTOR	21
• REDUCING HOSE CONNECTOR	21
• HOSE CONNECTOR	22
• Y HOSE CONNECTOR	22
• UNION T HOSE CONNECTOR	22
• MALE BRANCH T HOSE CONNECTOR	23
• FLANGE BRANCH T HOSE CONNECTOR	23
• REDUCING HOSE CONNECTOR	24

• FEMALE SWIVEL STRAIGHT HOSE CONNECTOR - CONICAL SEAT	24
• FEMALE SWIVEL STRAIGHT HOSE CONNECTOR	24
• FLANGE PIPE ELBOW	25
• SNAP CLIP ACETAL	25

PIPE FITTINGS

• PANEL MOUNTING NUT	26
• PIPE REDUCING NIPPLE	26
• PIPE HEX NIPPLE	26
• PIPE ADAPTOR	27
• PIPE BUSHING	27
• FEMALE PIPE COUPLING	28
• THREADED ELBOW	28
• THREADED REDUCING ELBOW	28
• HEX THREADED PLUG	28
• HEX THREADED FLANGE PLUG	29
• PIPE CAP	29
• PIPE REDUCING COUPLING	29
• PIPE T	30
• PIPE REDUCING BRANCH T	30
• PIPE REDUCING RUN T	30

GENERAL INDUSTRIAL ACCESSORIES

• QUICK RELEASE SOCKET	31
• PLUG - EXTERNAL THREAD	31
• PLUG - INTERNAL THREAD	31
• PLUG - HOSE CONNECTOR	32
• VALVE 1/4"	32
• SILENCER WITH RESTRICTOR VALVE FOR PNEUMATIC VALVES	32
• VALVE RELEASE / DRAIN VALVE	32

TUBES

• LDPE CONTROL TUBES	33
• LDPE TUBES	33
• HDPE TUBES	34
• PLASTICIZED PVC TUBES	34

AIR BLOW GUNS

• AIR BLOW GUN	35
• AIR BLOW GUN MARK II	35
• AIR BLOW GUN MARK III	35
• MINI AIR BLOW GUN	36
• SPRAY GUN	36
• FINE SPRAY	36
• 8 mm NYLON RETRACTABLE COIL	36
• SHORT SPRAY GUN	36

SPRAYING & FOGGING NOZZLES

• FAN SPRAY NOZZLES	37
• CONICAL SPRAY NOZZLE	37
• CONICAL SPRAY NOZZLE 1/8" NPT	37
• NON DROP CONICAL SPRAY NOZZLES 1/8" NPT	37
• CONICAL SPRAY NOZZLE 1/8" NPT WITH FILTER	38
• ADJUSTABLE NOZZLE	38
• NOZZLE FILTERS	38
• NON DROP NOZZLE FILTERS	38
• NUT 11/16" FOR NOZZLE	39
• 1/4" FEMALE STRAIGHT NOZZLE HOLDER	39
• 1/4" MALE STRAIGHT NOZZLE HOLDER	39
• 1/4" FEMALE 135° NOZZLE HOLDER	39
• PUSH-IN FITTING ADAPTOR FOR 1/8" NOZZLES	40
• MISTING UNIT MARK I	40
• FINGER FILTER	40

TIGHT PUSH FITTINGS

Material: Acetal copolymer resin.

Colour: Black.

Size colour code: Red support ring = mm

Yellow support ring = inch

 Working pressure: Up to 14 BAR (200 psi) at 20°C.

 Temperature: -20°C + 90°C (subject to application).

Assembly: The tube is pushed into the connector and secured by a nut tightening the outer surface of the tube and sealed with a grip ring and NBR "O" ring.

Advantages: Quick assembly without dismantling the fitting. Allowing uninterrupted passage of water or air. Uses: Hydraulic and pneumatic systems mostly indoor applications.

→ REDUCING UNION CONNECTOR



CAT. NO.	Tube O.D	Tube O.D	SW mm	SW1 mm	SW2 mm
22005604032	1/4"	3/16"	15	15	14
22005605032	5/16"	3/16"	16	17	14
22005605042	5/16"	1/4"	16	17	15
22005606042	3/8"	1/4"	19	19	15
22005606052	3/8"	5/16"	19	19	16
22005608052	1/2"	5/16"	22	22	16
22005608062	1/2"	3/8"	22	22	19
22005646442	6 mm	4 mm	15	15	14
22005648442	8 mm	4 mm	16	17	14
22005648462	8 mm	6 mm	16	17	15
22005650462	10 mm	6 mm	19	19	15
22005650482	10 mm	8 mm	19	19	16
22005652482	12 mm	8 mm	22	22	16
22005652502	12 mm	10 mm	22	22	19

→ UNION CONNECTOR

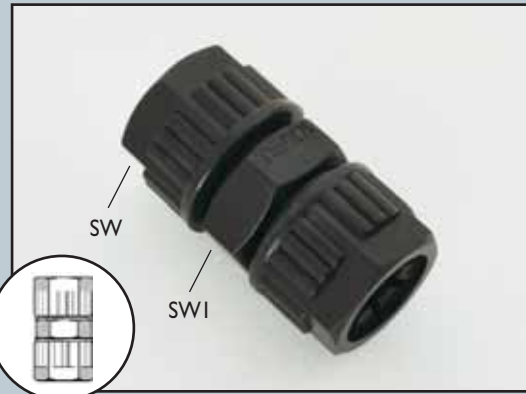

CAT. NO.	Tube O.D	SW mm	SW1 mm
22006203002	3/16"	14	14
22006204002	1/4"	15	15
22006205002	5/16"	16	16
22006206002	3/8"	19	19
22006208002	1/2"	22	22
22006244002	4 mm	14	14
22006246002	6 mm	15	15
22006248002	8 mm	16	16
22006250002	10 mm	19	19
22006252002	12 mm	22	22

→ MALE CONNECTOR



CAT. NO.	Tube O.D	Thread BSPT	SW mm	SW1 mm
22006803022	3/16"	1/8"	14	14
22006803042	3/16"	1/4"	14	14
22006804022	1/4"	1/8"	15	14
22006804042	1/4"	1/4"	15	15
22006805022	5/16"	1/8"	16	15
22006805042	5/16"	1/4"	16	17
22006806042	3/8"	1/4"	19	17
22006806062	3/8"	3/8"	19	19
22006808062	1/2"	3/8"	22	22
22006808082	1/2"	1/2"	22	22
22006844022	4 mm	1/8"	14	14
22006844042	4 mm	1/4"	14	14
22006846022	6 mm	1/8"	15	14
22006846042	6 mm	1/4"	15	15
22006848022	8 mm	1/8"	16	15
22006848042	8 mm	1/4"	16	17
22006850042	10 mm	1/4"	19	17
22006850062	10 mm	3/8"	19	19
22006852062	12 mm	3/8"	22	22
22006852082	12 mm	1/2"	22	22

→ OD-Outer diameter → SW-Standard Wrench
 → ID-Inner diameter → R-Radius

→ FEMALE CONNECTOR

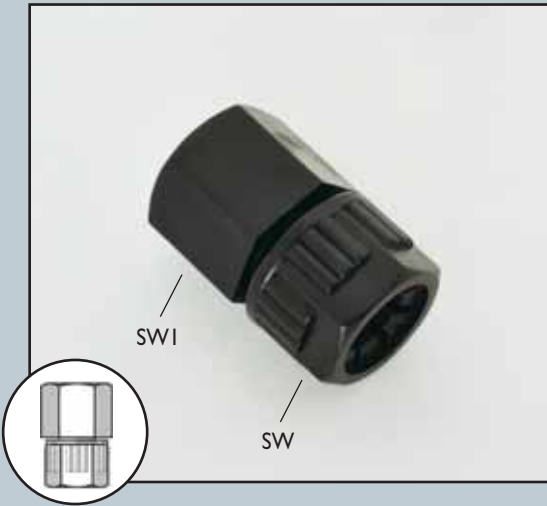

CAT.NO.	Tube O.D	Thread BSPT	SW mm	SW1 mm	Color
22006603022	3/16"	1/8"	14	15	■
22006603042	3/16"	1/4"	14	17.5	
22006604022	1/4"	1/8"	15	15.5	
22006604042	1/4"	1/4"	15	17.5	
22006605022	5/16"	1/8"	16	17	
22006605042	5/16"	1/4"	16	17	
22006605062	5/16"	3/8"	16	17	
22006605082	5/16"	1/2"	16	17	
22006606022	3/8"	1/8"	19	19	
22006606042	3/8"	1/4"	19	19	
22006606062	3/8"	3/8"	19	19	
22006606082	3/8"	1/2"	19	19	
22006608062	1/2"	3/8"	22	22	
22006608082	1/2"	1/2"	22	24	
22006644022	4 mm	1/8"	14	15	
22006644042	4 mm	1/4"	14	17.5	
22006646022	6 mm	1/8"	15	15	
22006646042	6 mm	1/4"	15	17	
22006648022	8 mm	1/8"	16	17	
22006648042	8 mm	1/4"	16	17	
22006648062	8 mm	3/8"	16	17	
22006648082	8 mm	1/2"	16	17	
22006650022	10 mm	1/8"	19	19	
22006650042	10 mm	1/4"	19	19	
22006650041	10 mm	1/4"	19	19	
22006650047	10 mm	1/4"	19	19	
22006650062	10 mm	3/8"	19	19.5	
22006650082	10 mm	1/2"	19	19.5	
22006652062	12 mm	3/8"	22	22.5	
22006652082	12 mm	1/2"	22	24	

CAT.NO.	Tube O.D	Thread NPT	SW mm	SW1 mm	Color
22286602023	5/32"	1/8"	14	15	■
22286602043	5/32"	1/4"	14	17.5	
22286604023	1/4"	1/8"	15	15.5	
22286604043	1/4"	1/4"	15	17.5	
22286605023	5/16"	1/8"	16	17	
22286605043	5/16"	1/4"	16	17	
22286605063	5/16"	3/8"	16	22	
22286605083	5/16"	1/2"	16	24	
22286606023	3/8"	1/8"	19	19	
22286606043	3/8"	1/4"	19	19	
22286606063	3/8"	3/8"	19	19	
22286606083	3/8"	1/2"	19	19	
22286608063	1/2"	3/8"	22	22.5	
22286608083	1/2"	1/2"	22	24	

→ UNION ELBOW



CAT.NO.	Tube O.D	SW mm	SW1 mm
22006503002	3/16"	14	8.5
22006504002	1/4"	15	10
22006505002	5/16"	16	12
22006506002	3/8"	19	14
22006508002	1/2"	22	17
22006544002	4 mm	14	8
22006546002	6 mm	15	10
22006548002	8 mm	16	12
22006550002	10 mm	19	15
22006552002	12 mm	22	17

→ M A L E E L B O W



CAT. NO.	Tube O.D	Thread BSPT	SW mm	SWI mm
22006903022	3/16"	1/8"	14	8
22006903042	3/16"	1/4"	14	8
22006904022	1/4"	1/8"	15	10
22006904042	1/4"	1/4"	15	10
22006905022	5/16"	1/8"	16	12
22006905042	5/16"	1/4"	16	12
22006906042	3/8"	1/4"	19	15
22006906062	3/8"	3/8"	19	15
22006908062	1/2"	3/8"	22	17
22006908082	1/2"	1/2"	22	17
22006944022	4 mm	1/8"	14	8
22006944042	4 mm	1/4"	14	8
22006946022	6 mm	1/8"	15	10
22006946042	6 mm	1/4"	15	10
22006948022	8 mm	1/8"	16	12
22006948042	8 mm	1/4"	16	12
22006950042	10 mm	1/4"	19	15
22006950062	10 mm	3/8"	19	15
22006952062	12 mm	3/8"	22	17
22006952082	12 mm	1/2"	22	17

→ T C O N N E C T O R



CAT. NO.	Tube O.D	SW mm	SWI mm
22006403032	3/16"	14	8
22006404042	1/4"	15	10
22006405052	5/16"	16	12
22006406062	3/8"	19	15
22006408082	1/2"	22	17
22006444442	4 mm	14	8
22006446462	6 mm	15	10
22006448482	8 mm	16	12
22006450502	10 mm	19	15
22006452522	12 mm	22	17

→ OD-Outer diameter → SW-Standard Wrench
 → ID-Inner diameter → R-Radius

→ MALE BRANCH T



CAT.NO.	Tube O.D	Thread BSPT	SW mm	SWI mm
22007103022	3/16"	1/8"	14	8
22007103042	3/16"	1/4"	14	8
22007104022	1/4"	1/8"	15	10
22007104042	1/4"	1/4"	15	10
22007105022	5/16"	1/8"	16	12
22007105042	5/16"	1/4"	16	12
22007106042	3/8"	1/4"	19	15
22007106062	3/8"	3/8"	19	15
22007108062	1/2"	3/8"	22	17
22007108082	1/2"	1/2"	22	17
22007144022	4 mm	1/8"	14	8
22007144042	4 mm	1/4"	14	8
22007146022	6 mm	1/8"	15	10
22007146042	6 mm	1/4"	15	10
22007148022	8 mm	1/8"	16	12
22007148042	8 mm	1/4"	16	12
22007150042	10 mm	1/4"	19	15
22007150062	10 mm	3/8"	19	15
22007152062	12 mm	3/8"	22	17
22007152082	12 mm	1/2"	22	17

→ MALE RUN T



CAT.NO.	Tube O.D	Thread BSPT	SW mm	SWI mm
22007203022	3/16"	1/8"	14	8
22007203042	3/16"	1/4"	14	8
22007204022	1/4"	1/8"	15	10
22007204042	1/4"	1/4"	15	10
22007205022	5/16"	1/8"	16	12
22007205042	5/16"	1/4"	16	12
22007206042	3/8"	1/4"	19	15
22007206062	3/8"	3/8"	19	15
22007208062	1/2"	3/8"	22	17
22007208082	1/2"	1/2"	22	17
22007244022	4 mm	1/8"	14	8
22007244042	4 mm	1/4"	14	8
22007246022	6 mm	1/8"	15	10
22007246042	6 mm	1/4"	15	10
22007248022	8 mm	1/8"	16	12
22007248042	8 mm	1/4"	16	12
22007250042	10 mm	1/4"	19	15
22007250062	10 mm	3/8"	19	15
22007252062	12 mm	3/8"	22	17
22007252082	12 mm	1/2"	22	17

BARB BLOCK FITTINGS

Material: Fiberglass reinforced polypropylene.

Colour: Blue.

 Working pressure: Up to 14 BAR (200 psi) at 20°C.

 Temperature: 4°C + 90°C (subject to application).

Assembly: The nut is threaded onto the tube, which is dressed onto the barb. The nut is tightened on the inner and outer surfaces of the tube, insuring tight fitting on various pipe tolerances.

Advantages: Quick assembly.

Good resistance to chemicals and fertilizers.

Excellent for indoor, outdoor and field applications.

Uses: Hydraulic systems.

→ **REDUCING CONNECTOR**

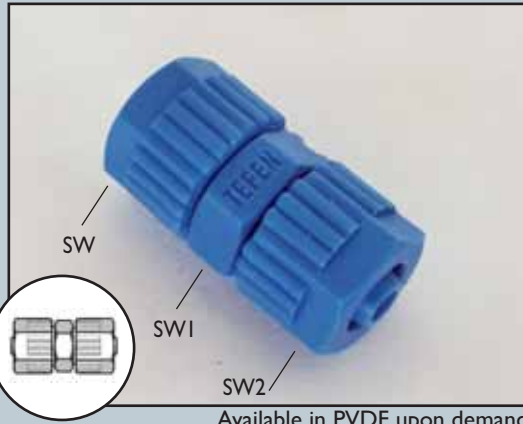

Available in PVDF upon demand

CAT.NO.	Tube O.D	Tube O.D	SW mm	SW1 mm	SW2 mm	Color
22045648468	8 mm	6 mm	14	14	14	

CAT.NO.	Tube O.D	Tube O.D	SW mm	SW1 mm	SW2 mm	Color
22045605048	5/16"	1/4"	14	14	14	

CAT.NO.	Tube O.D	Tube O.D	SW mm	SW1 mm	SW2 mm	Color
22245605043	5/16"	1/4"	14	14	14	

→ **UNION CONNECTOR**

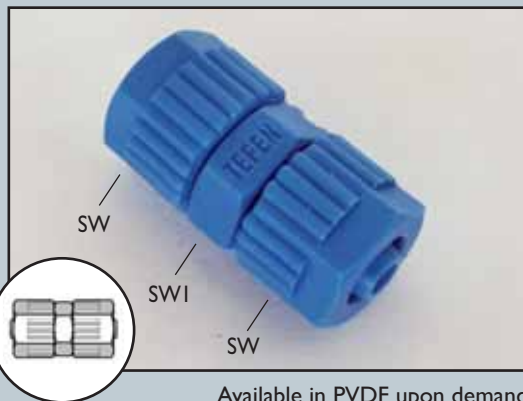

Available in PVDF upon demand

CAT.NO.	Tube O.D	SW mm	SW1 mm	Color
22046246008	6 mm	14	14	
22046248008	8 mm	14	14	
22046252008	12 mm	19	19	

CAT.NO.	Tube O.D	SW mm	SW1 mm	Color
22046204008	1/4"	14	14	
22046205008	5/16"	14	14	
22046208008	1/2"	19	19	

CAT.NO.	Tube O.D	SW mm	SW1 mm	Color
22246204003	1/4"	14	14	
22246205003	5/16"	14	14	
22246208003	1/2"	19	19	

THE LAST DIGIT OF THE CAT. NO. MARKS THE COLOR:

 8 BSPT with mm tube size

 8 BSPT with inch tube size

 3 NPT with inch tube size

→ MALE CONNECTOR

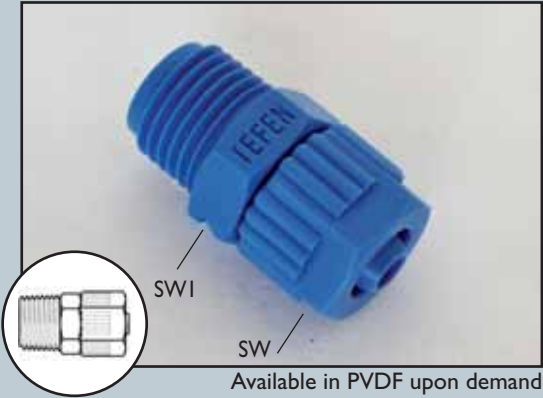

CAT. NO.	Tube O.D	Thread BSPT	SW mm	SWI mm	Color
22046846028	6 mm	1/8"	14	13	Blue
22046846048	6 mm	1/4"	14	15	
22046846068	6 mm	3/8"	14	18	
22046846088	6 mm	1/2"	14	22	
22046846128	6 mm	3/4"	14	27	
22046848028	8 mm	1/8"	14	13	
22046848048	8 mm	1/4"	14	15	
22046848068	8 mm	3/8"	14	18	
22046848088	8 mm	1/2"	14	22	
22046848128	8 mm	3/4"	14	27	
22046850048	10 mm	1/4"	17	17	
22046850068	10 mm	3/8"	17	17	
22046850088	10 mm	1/2"	17	22	
22046850128	10 mm	3/4"	17	27	
22046852048	12 mm	1/4"	19	14	
22046852068	12 mm	3/8"	19	18	
22046852088	12 mm	1/2"	19	22	
22046852128	12 mm	3/4"	19	27	
22046848022	8 mm	1/8"	14	13	Black

CAT. NO.	Tube O.D	Thread BSPT	SW mm	SWI mm	Color
22046804028	1/4"	1/8"	14	13	Blue/Yellow
22046804048	1/4"	1/4"	14	15	
22046804068	1/4"	3/8"	14	18	
22046804088	1/4"	1/2"	14	22	
22046804128	1/4"	3/4"	14	27	
22046805028	5/16"	1/8"	14	13	
22046805048	5/16"	1/4"	14	15	
22046805068	5/16"	3/8"	14	18	
22046806048	3/8"	1/4"	17	17	
22046806068	3/8"	3/8"	17	17	
22046806088	3/8"	1/2"	17	22	
22046806128	3/8"	3/4"	17	27	
22046808048	1/2"	1/4"	19	14	
22046808068	1/2"	3/8"	19	18	
22046808088	1/2"	1/2"	19	22	
22046808128	1/2"	3/4"	19	27	

CAT. NO.	Tube O.D	Thread NPT	SW mm	SWI mm	Color
22246804023	1/4"	1/8"	14	13	Grey
22246804043	1/4"	1/4"	14	15	
22246804083	1/4"	1/2"	14	22	
22246804123	1/4"	3/4"	14	27	
22246805023	5/16"	1/8"	14	13	
22246805043	5/16"	1/4"	14	15	
22246805063	5/16"	3/8"	14	18	
22246805083	5/16"	1/2"	14	22	
22246805123	5/16"	3/4"	14	27	
22246806043	3/8"	1/4"	17	15	
22246806063	3/8"	3/8"	17	18	
22246806083	3/8"	1/2"	17	22	
22246806123	3/8"	3/4"	17	27	
22246808043	1/2"	1/4"	19	15	
22246808063	1/2"	3/8"	19	18	
22246808083	1/2"	1/2"	19	22	
22246808123	1/2"	3/4"	19	18	

→ OD-Outer diameter → SW-Standard Wrench
→ ID-Inner diameter → R-Radius

→ FEMALE CONNECTOR

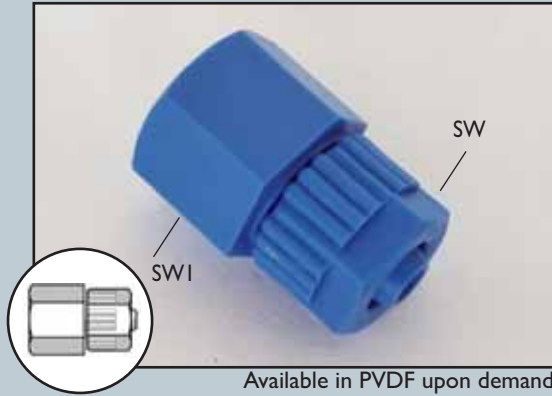

Available in PVDF upon demand

CAT. NO.	Tube O.D	Thread BSPT	Thread mm	SW mm	SWI mm	Color
22046646028	6 mm	1/8"		14	14	
22046646048	6 mm	1/4"		14	17	
22046648028	8 mm	1/8"		14	14	
22046648048	8 mm	1/4"		14	17	
22046648548	8 mm		M14x1.5	14	17	
22046648068	8 mm	3/8"		14	22	
22046648088	8 mm	1/2"		14	26	
22046650048	10 mm	1/4"		17	17	
22046650068	10 mm	3/8"		17	22	
22046650088	10 mm	1/2"		17	26	

CAT. NO.	Tube O.D	Thread BSPT	SW mm	SWI mm	Color
22046604028	1/4"	1/8"	14	14	
22046604048	1/4"	1/4"	14	17	
22046605028	5/16"	1/8"	14	14	
22046605048	5/16"	1/4"	14	17	
22046605068	5/16"	3/8"	14	22	
22046605088	5/16"	1/2"	14	26	
22046606048	3/8"	1/4"	17	17	
22046606068	3/8"	3/8"	17	22	
22046606088	3/8"	1/2"	17	26	

CAT. NO.	Tube O.D	Thread NPT	SW mm	SWI mm	Color
22246604023	1/4"	1/8"	14	14	
22246605023	5/16"	1/8"	14	14	
22246605043	5/16"	1/4"	14	17	
22246605063	5/16"	3/8"	14	22	
22246605083	5/16"	1/2"	14	26	
22246606043	3/8"	1/4"	17	17	
22246606063	3/8"	3/8"	17	22	
22246606083	3/8"	1/2"	17	26	

→ UNION ELBOW

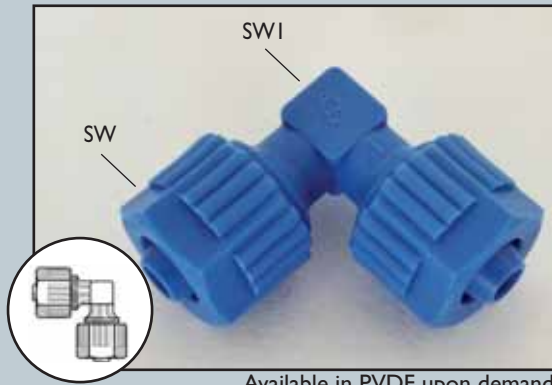

Available in PVDF upon demand

CAT. NO.	Tube O.D	SW mm	SWI mm	Color
22046546008	6 mm	14	8	
22046548008	8 mm	14	8	
22046552008	12 mm	19	15	

CAT. NO.	Tube O.D	SW mm	SWI mm	Color
22046504008	1/4"	14	8	
22046505008	5/16"	14	8	
22046508008	1/2"	19	15	
22046508002	1/2"	19	15	

CAT. NO.	Tube O.D	SW mm	SWI mm	Color
22246504003	1/4"	14	8	
22246505003	5/16"	14	8	
22246508003	1/2"	19	15	

→ REDUCING UNION ELBOW

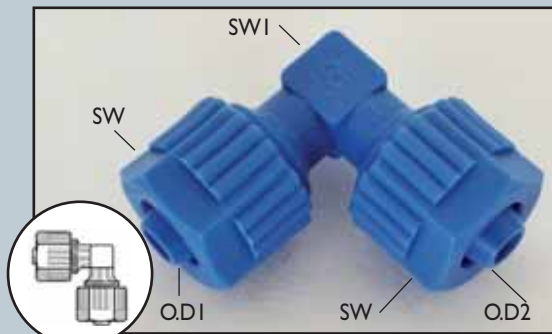

Available in PVDF upon demand

CAT. NO.	Tube O.D1	Tube O.D2	SW mm	SWI mm	Color
22045748468	8 mm	6 mm	14	8	

THE LAST DIGIT OF THE CAT. NO. MARKS THE COLOR:

8

BSPT with mm tube size

BSPT with inch tube size

NPT with inch tube size

→ MALE ELBOW

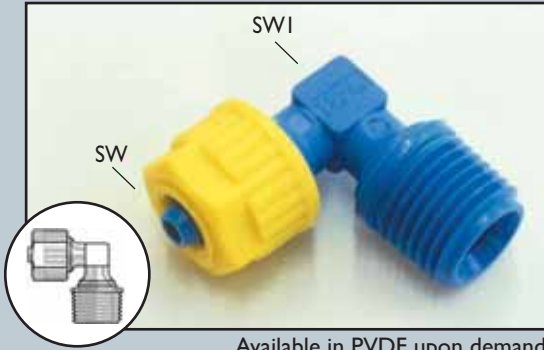

Available in PVDF upon demand

CAT.NO.	Tube O.D.	Thread BSPT	SW mm	SWI mm	Color	
22046946028	6 mm	1/8"	14	8		
22046946048	6 mm	1/4"	14	8		
22046948028	8 mm	1/8"	14	8		
22046948048	8 mm	1/4"	14	8		
22046948068	8 mm	3/8"	14	8		
22046952048	12 mm	1/4"	19	15		
22046952068	12 mm	3/8"	19	15		
22046952088	12 mm	1/2"	19	15		
22046946022	6 mm	1/8"	14	8		
22046948022	8 mm	1/8"	14	8		

CAT.NO.	Tube O.D.	Thread BSPT	SW mm	SWI mm	Color	
22046904028	1/4"	1/8"	14	8		
22046904048	1/4"	1/4"	14	8		
22046905028	5/16"	1/8"	14	8		
22046905048	5/16"	1/4"	14	8		
22046905068	5/16"	3/8"	14	8		
22046908048	1/2"	1/4"	19	15		
22046908068	1/2"	3/8"	19	15		
22046908088	1/2"	1/2"	19	15		
22046908082	1/2"	1/2"	19	15		

CAT.NO.	Tube O.D.	Thread NPT	SW mm	SWI mm	Color
22246904023	1/4"	1/8"	14	8	
22246904043	1/4"	1/4"	14	8	
22246905023	5/16"	1/8"	14	8	
22246905043	5/16"	1/4"	14	8	

→ FEMALE ELBOW



Available in PVDF upon demand

CAT.NO.	Tube O.D.	Thread BSPT	SW mm	SWI mm	Color	
22046046028	6 mm	1/8"	14	8		
22046046048	6 mm	1/4"	14	8		
22046048048	8 mm	1/4"	14	8		
22046046022	6 mm	1/8"	14	8		
22046046042	6 mm	1/4"	14	8		
22046048042	8 mm	1/4"	14	8		

THE LAST DIGIT OF THE CAT. NO. MARKS THE COLOR:

8 BSPT with mm tube size

8 BSPT with inch tube size

3 NPT with inch tube size

→ MALE BRANCH T

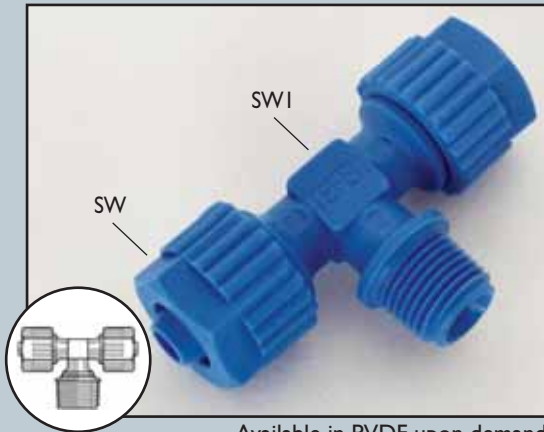

Available in PVDF upon demand

CAT.NO.	Tube O.D.	Thread BSPT	SW mm	SWI mm	Color
22047146028	6 mm	1/8"	14	8	Blue
22047146048	6 mm	1/4"	14	8	Blue
22047148028	8 mm	1/8"	14	8	Blue
22047148048	8 mm	1/4"	14	8	Blue
22047148068	8 mm	3/8"	14	8	Blue
22047152048	12 mm	1/4"	19	15	Blue
22047152068	12 mm	3/8"	19	15	Blue
22047152088	12 mm	1/2"	19	15	Blue
22047146042	6 mm	1/4"	14	8	Black
22047148022	8 mm	1/8"	14	8	Black
22047148042	8 mm	1/4"	14	8	Black

CAT.NO.	Tube O.D.	Thread BSPT	SW mm	SWI mm	Color
22047104028	1/4"	1/8"	14	8	Blue/Yellow
22047104048	1/4"	1/4"	14	8	Blue/Yellow
22047105028	5/16"	1/8"	14	8	Blue/Yellow
22047105048	5/16"	1/4"	14	8	Blue/Yellow
22047105068	5/16"	3/8"	14	8	Blue/Yellow
22047108048	1/2"	1/4"	19	15	Blue/Yellow
22047108068	1/2"	3/8"	19	15	Blue/Yellow

CAT.NO.	Tube O.D.	Thread NPT	SW mm	SWI mm	Color
22247104023	1/4"	1/8"	14	8	Grey
22247104043	1/4"	1/4"	14	8	Grey
22247105023	5/16"	1/8"	14	8	Grey
22247105043	5/16"	1/4"	14	8	Grey
22247108063	1/2"	3/8"	19	15	Grey
22247108083	1/2"	1/2"	19	15	Grey

→ FEMALE BRANCH T



Available in PVDF upon demand

CAT.NO.	Tube O.D.	Thread BSPT	SW mm	SWI mm	Color
22047346028	6 mm	1/8"	14	8	Blue
22047348048	8 mm	1/4"	14	8	Blue
22047304028	1/4"	1/8"	14	8	Blue/Yellow
22047305048	5/16"	1/4"	14	8	Blue/Yellow

→ OD-Outer diameter → SW-Standard Wrench
→ ID-Inner diameter → R-Radius

THE LAST DIGIT OF THE CAT. NO. MARKS THE COLOR:

8 BSPT with mm tube size

8 BSPT with inch tube size

3 NPT with inch tube size

→ MALE RUN T

Available in PVDF upon demand

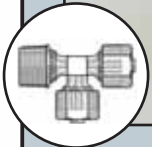

CAT.NO.	Tube	Thread BSPT	SW mm	SWI mm	Color
22047246028	6 mm	1/8"	14	8	
22047246048	6 mm	1/4"	14	8	
22047248028	8 mm	1/8"	14	8	
22047248048	8 mm	1/4"	14	8	
22047248068	8 mm	3/8"	14	8	
22047252048	12 mm	1/4"	19	15	
22047252068	12 mm	3/8"	19	15	
22047252088	12 mm	1/2"	19	15	

CAT.NO.	Tube	Thread BSPT	SW mm	SWI mm	Color
22047204028	1/4"	1/8"	14	8	
22047204048	1/4"	1/4"	14	8	
22047205028	5/16"	1/8"	14	8	
22047205048	5/16"	1/4"	14	8	
22047205068	5/16"	3/8"	14	8	
22047208048	1/2"	1/4"	19	15	
22047208068	1/2"	3/8"	19	15	
22047208088	1/2"	1/2"	19	15	

CAT.NO.	Tube	Thread NPT	SW mm	SWI mm	Color
22247204023	1/4"	1/8"	14	8	
22247204043	1/4"	1/4"	14	8	
22247205023	5/16"	1/8"	14	8	
22247205043	5/16"	1/4"	14	8	
22247205063	5/16"	3/8"	14	8	

→ UNION T

Available in PVDF upon demand

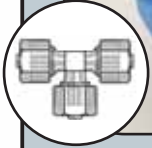
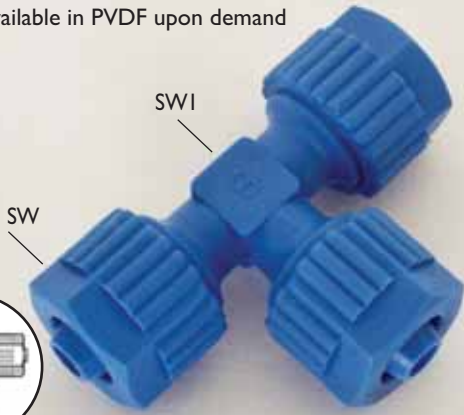

CAT.NO.	Tube O.D	SW mm	SWI mm	Color
22046446468	6 mm	14	8	
22046448488	8 mm	14	8	
22046452528	12 mm	19	14	

CAT.NO.	Tube O.D	SW mm	SWI mm	Color
22046404041	1/4"	14	8	
22046404048	1/4"	14	8	
22046405058	5/16"	14	8	
22046408088	1/2"	19	14	
22046404042	1/4"	14	8	
22046408082	1/2"	19	14	

CAT.NO.	Tube O.D	SW mm	SWI mm	Color
22246404043	1/4"	14	8	
22246405053	5/16"	14	8	
22246408083	1/2"	19	14	

Available in PVDF upon demand

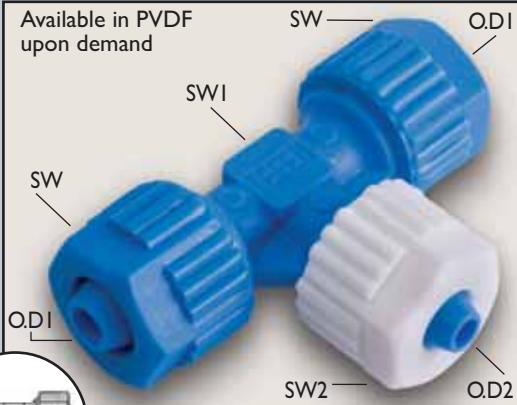

CAT.NO.	Tube O.D1	Tube O.D2	SW mm	SW2 mm	SWI mm	Color
22045846488	6 mm	8 mm	14	14	8	
22045848488	8 mm	6 mm	14	14	8	

THE LAST DIGIT OF THE CAT. NO. MARKS THE COLOR:

- BSPT with mm tube size
- BSPT with inch tube size
- NPT with inch tube size

→ OD-Outer diameter → SW-Standard Wrench
→ ID-Inner diameter → R-Radius

→ DOUBLE BANJO BODY

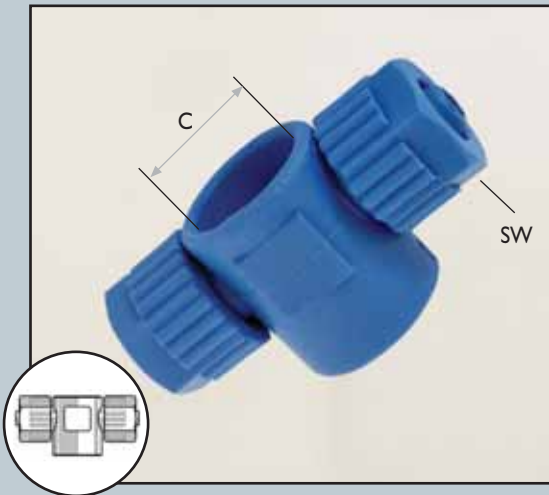

CAT.NO.	Tube O.D	Tube O.D	C Bore	SW mm	Color
22044946028	6 mm	6 mm	1/8"	14	
22044946048	6 mm	6 mm	1/4"	14	
22044986028	8 mm	6 mm	1/8"	14	
22044986048	8 mm	6 mm	1/4"	14	
22044988028	8 mm	8 mm	1/8"	14	
22044988048	8 mm	8 mm	1/4"	14	

CAT.NO.	Tube O.D	Tube O.D	C Bore	SW mm	Color
22044904028	1/4"	1/4"	1/8"	14	
22044904048	1/4"	1/4"	1/4"	14	
22044954028	5/16"	1/4"	1/8"	14	
22044954048	5/16"	1/4"	1/4"	14	
22044905028	5/16"	5/16"	1/8"	14	
22044905048	5/16"	5/16"	1/4"	14	

→ SINGLE BANJO BODY

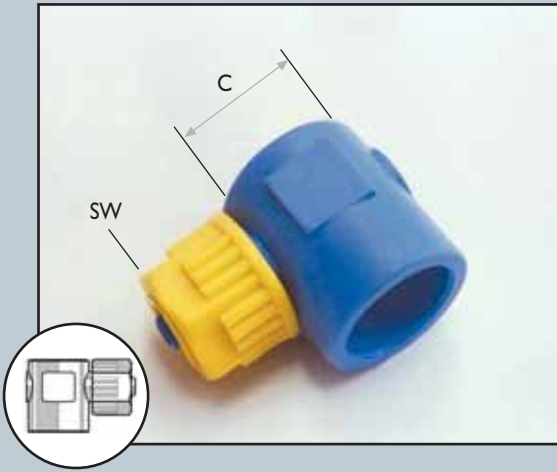

CAT.NO.	Tube O.D	SW mm	C-Bore	Color
22044846028	6 mm	14	1/8"	
22044846048	6 mm	14	1/4"	
22044848028	8 mm	14	1/8"	
22044848048	8 mm	14	1/4"	

CAT.NO.	Tube O.D	SW mm	C-Bore	Color
22044804028	1/4"	14	1/8"	
22044804048	1/4"	14	1/4"	
22044805028	5/16"	14	1/8"	
22044805048	5/16"	14	1/4"	

→ DOUBLE BANJO BODY BOLT

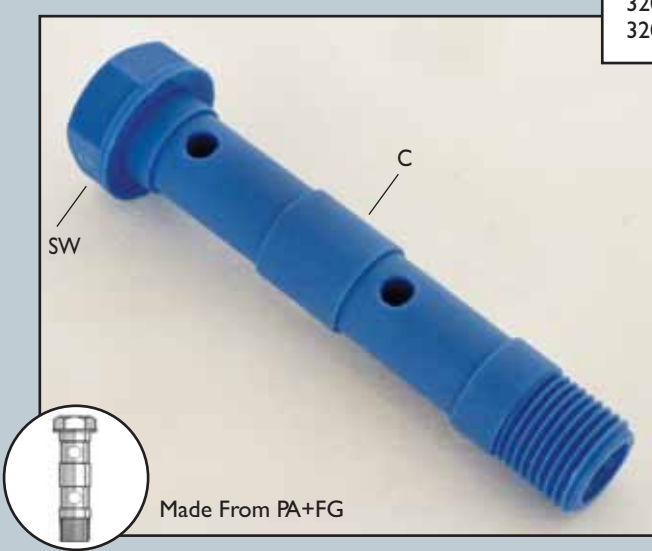

CAT.NO.	SW mm	C-Bore	Thread BSP
32045102028	16 mm	1/8"	1/8"
32045104048	16 mm	1/4"	1/4"

→ OD-Outer diameter → SW-Standard Wrench
→ ID-Inner diameter → R-Radius

→ SINGLE BANJO BODY BOLT

CAT.NO.	SW mm	C-Bore	Thread BSP
32045002028	16 mm	1/8"	1/8"
32045004048	16 mm	1/4"	1/4"

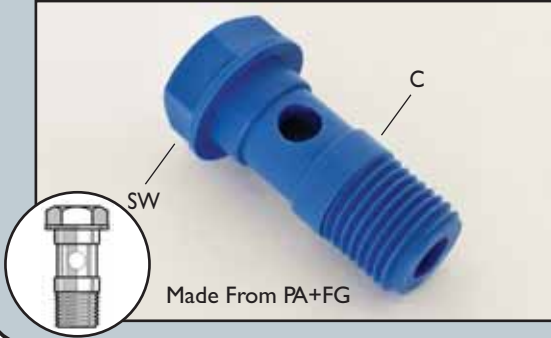

→ NUT FOR UNION CONNECTORS

CAT.NO.	Colour	Hose O.D	SW
32046104001	white	1/4"	14
32046104002	black	1/4"	14
32046104009	yellow	1/4"	14
32046108001	white long	1/2" (12 mm)	19
32046108002	black long	1/2" (12 mm)	19
32046108006	red long	1/2" (12 mm)	19
32046108008	blue long	1/2" (12 mm)	19
32046108009	yellow long	1/2" (12 mm)	19
32046108012	black short	1/2" (12 mm)	19
32046108019	yellow short	1/2" (12 mm)	19
32046146001	white	6 mm	14
32046146006	red	6 mm	14
32046146008	blue	6 mm	14
32046146009	yellow	6 mm	14
32046148001	white	8 mm	14
32046148006	red	8 mm	14
32046148008	blue	8 mm	14
32046148009	yellow	8 mm	14
32046150008	blue	10 mm	17
32046150009	yellow	10 mm	17
32046150002	black	10 mm	17

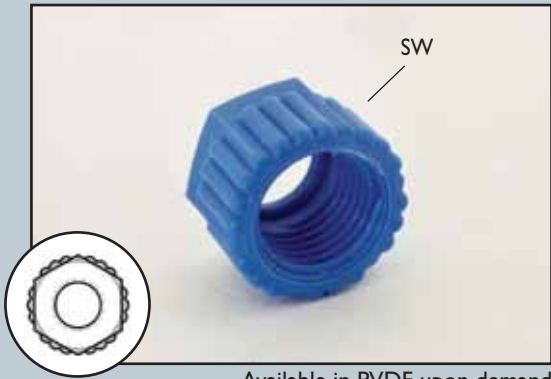

Available in PVDF upon demand

→ NUT FOR UNION CONNECTOR inch

CAT.NO.	Hose O.D	SW	Colour
32246104003	1/4"	14	
32246105003	5/16"	14	
32246106003	3/8"	17	
32246108003	1/2"	19	



Available in PVDF upon demand

→ FEMALE UNION SWIVEL CONNECTOR



CAT. NO.	Tube O.D	Thread BSPT	SW mm
22044704121	1/4"	3/4"	14
22044746121	6 mm	3/4"	14
22044648121	8 mm	3/4"	14
22044750121	10 mm	3/4"	17
22044752121	12 mm	3/4"	19

CAT. NO.	Tube O.D	Thread BSPT	SW mm	SWI mm
22044746061	6 mm	3/8"	14	20
22044746081	6 mm	1/2"	14	24
22044748061	8 mm	3/8"	14	20
22044748081	8 mm	1/2"	14	24
22044750081	10 mm	1/2"	17	24

Fiber glass reinforced polypropylene tube connectors feature barb onto which the tube is dressed and tightened with nut on inner and outer surfaces of tube. Note: 3/4" female swivel sealed with flat rubber seal.

Working Pressure: Up to 14 BAR (200 psi).

Advantages: Good resistance to chemicals and fertilizers.

Excellent for outdoor and field applications. Temperature: 90°C max.

→ FEMALE ELBOW SWIVEL CONNECTOR



CAT. NO.	Tube O.D	Thread BSPT	SW mm
22044548121	8 mm	3/4"	30

→ WATER PRE FILTER

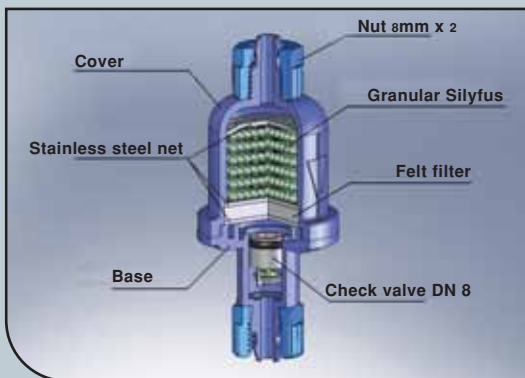

	Model White	Model Blue
	220467T9101	220467T9008
Filter Micron (mesh)	150 (100)	150 (100)
Maximum flow rate L/M	8	8
Maximum flow rate G/M	2.11	2.11
Hose connector inlet/outlet (inch)	8 mm (5/16")	8 mm (5/16")
Anti scale substance	-	✓
Check valve	-	✓
Diameter mm (inch)	32 (1 1/4")	32 (1 1/4")
Length mm (inch)	71.7 (2 13/16")	71.7 (2 13/16")

AGRICULTURE PIPE FITTINGS

Material: Polypropylene.

Colour: Black.



Working pressure: Up to 14 BAR (200 psi) at 20°C.



Temperature: 4°C + 90°C (subject to application).

Assembly: Tubes dressed onto barbed tail of fitting.

Advantages: Good resistance to chemicals and fertilizers.

Uses: Fittings especially suitable for connecting L.D.P.E. agricultural pipes, Class 2.5 and Class 4 and other flexible pipes.

→ FEMALE SWIVEL HOSE CONNECTOR WITH WASHER

CAT. NO.	D Hose I.D.	Thread BSP	SW mm
22454746122	6 mm	3/4"	32
22454748122	8 mm	3/4"	32
22454748162	8 mm	1"	38
22454750062	10 mm	3/8"	32
22454750122	10 mm	3/4"	32
22454752082	12 mm	1/2"	32
22454752122	12 mm	3/4"	32
22454752162	12 mm	1"	38
22454754122	14 mm	3/4"	32
22454754162	14 mm	1"	38
22454756122	16 mm	3/4"	32
22454756162	16 mm	1"	38
22454759122	19 mm	3/4"	32
22454759162	19 mm	1"	38
22454706122	3/8"	3/4"	32
22454708162	1/2"	1"	38
22454708122	1/2"	3/4"	32
22454710162	5/8"	1"	38
22454710122	5/8"	3/4"	32
22454712162	3/4"	1"	38
22454712122	3/4"	3/4"	32

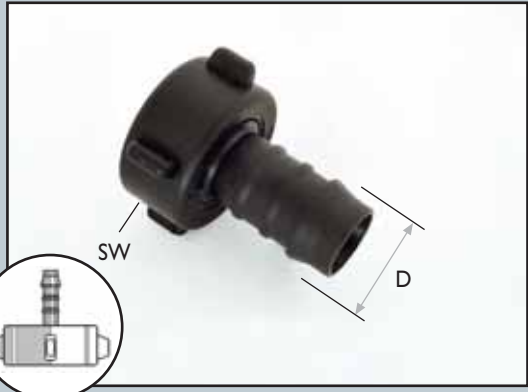

Polypropylene swivel hose connector with flat seal. Good resistance to chemicals and fertilizers. Suitable for outdoors use in irrigation systems and gardens.

→ MALE STRAIGHT HOSE CONNECTOR

CAT. NO.	Hose O.D	Thread BSPT	SW mm	
12456812022	12 mm	1/8"	14	
12456812042	12 mm	1/4"	14	
12456812062	12 mm	3/8"	17	
12456812082	12 mm	1/2"	22	
12456812122	12 mm	3/4"	27	
12456816042	16 mm	1/4"	22	
12456816082	16 mm	1/2"	22	
12456816122	16 mm	3/4"	27	
12456820082	20 mm	1/2"	22	
12456820122	20 mm	3/4"	27	
12456820162	20 mm	1"	29	
12456825082	25 mm	1/2"	22	
12456825122	25 mm	3/4"	27	
12456825162	25 mm	1"	29	
12466817083	17 mm	1/2"	27	SHARP BARB ACETAL
12466817123	17 mm	3/4"	27	SHARP BARB ACETAL



→ UNION HOSE CONNECTOR

CAT. NO.	Hose OD	Colour	
12456212002	12 mm		
12456220002	20 mm		
12456225002	25 mm		
12456216002	16 mm		
12466216002	16 mm	BLACK	SHARP BARB ACETAL
12466216003	16 mm	BROWN	SHARP BARB ACETAL
12466217003	17 mm	BROWN	SHARP BARB ACETAL



→ OD-Outer diameter → SW-Standard Wrench
 → ID-Inner diameter → R-Radius

→ REDUCING HOSE CONNECTOR

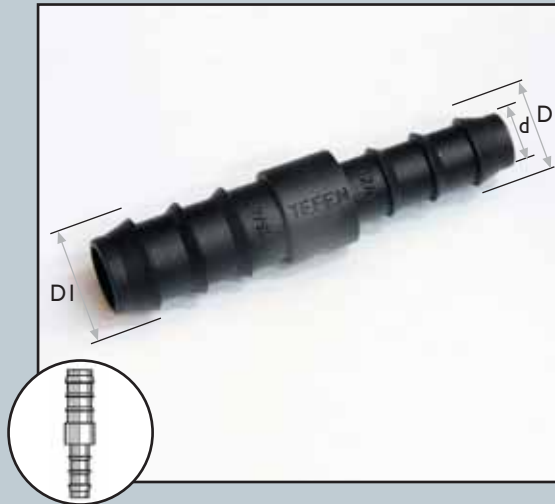

CAT.NO.	D Hose O.D	DI Hose OD	d Hose ID	
I2455648122		12 mm	8 mm	
I2455612162	12 mm	16 mm		
I2455612202	12 mm	20 mm		
I2455616202	16 mm	20 mm		
I2455620252	20 mm	25 mm		
I2455652202		20 mm	12 mm	
I2455656202		20 mm	16 mm	
I2455659202		20 mm	19 mm	
I2455659252		25 mm	19 mm	
I2465612172	12 mm	17 mm		SHARP BARB ACETAL
I2465616172	16 mm	17 mm		SHARP BARB ACETAL
I2465617202	17 mm	20 mm		SHARP BARB ACETAL

→ MALE ELBOW HOSE CONNECTOR



CAT.NO.	Hose O.D	Thread BSPT	SW mm	
I2456912042	12 mm	1/4"	14	
I2456912062	12 mm	3/8"	14	
I2456912082	12 mm	1/2"	22	
I2456912122	12 mm	3/4"	27	
I2456916062	16 mm	3/8"	22	
I2456916082	16 mm	1/2"	22	
I2456916122	16 mm	3/4"	27	
I2456920082	20 mm	1/2"	22	
I2456920122	20 mm	3/4"	27	
I2456925082	25 mm	1/2"	27	
I2456925122	25 mm	3/4"	27	
I2466917083	17 mm	1/2"	22	SHARP BARB ACETAL
I2466917123	17 mm	3/4"	22	SHARP BARB ACETAL

→ REDUCING ELBOW HOSE CONNECTOR



CAT.NO.	D Hose O.D	DI Hose O.D	d Hose ID
I2456612162	12 mm	16 mm	
I2456612202	12 mm	20 mm	
I2456616202	16 mm	20 mm	
I2456620252	20 mm	25 mm	
I2456652202		20 mm	12 mm
I2456656202		20 mm	16 mm
I2456659202		20 mm	19 mm
I2456659252		25 mm	19 mm

→ OD-Outer diameter → SW-Standard Wrench
→ ID-Inner diameter → R-Radius

→ ELBOW HOSE CONNECTOR



CAT. NO.	Hose O.D	
12456512002	12 mm	SHARP BARB ACETAL SHARP BARB ACETAL
12456516002	16 mm	
12456520002	20 mm	
12456525002	25 mm	
12466516003	16 mm	
12466517003	17 mm	

→ MALE BRANCHT HOSE CONNECTOR



CAT. NO.	Hose O.D	Thread BSPT	SW mm	
12457112042	12 mm	1/4"	14	SHARP BARB ACETAL SHARP BARB ACETAL
12457112062	12 mm	3/8"	22	
12457112082	12 mm	1/2"	22	
12457112122	12 mm	3/4"	27	
12457116062	16 mm	3/8"	17	
12457116082	16 mm	1/2"	22	
12457116122	16 mm	3/4"	27	
12457120082	20 mm	1/2"	22	
12457120122	20 mm	3/4"	27	
12457125082	25 mm	1/2"	22	
12457125122	25 mm	3/4"	27	
12467117083	17 mm	1/2"	22	
12467117123	17 mm	3/4"	27	

→ T HOSE CONNECTOR



CAT. NO.	Hose O.D	
12456412122	12 mm	SHARP BARB ACETAL SHARP BARB ACETAL
12456416162	16 mm	
12456420202	20 mm	
12456425252	25 mm	
12466416163	16 mm	
12466417173	17 mm	

→ REDUCING T HOSE CONNECTOR



CAT. NO.	D Hose O.D	DI Hose O.D	d Hose I.D
12457212162	12 mm	16 mm	6 mm 12 mm 16 mm 19 mm
12457216202	16 mm	20 mm	
12457220252	20 mm	25 mm	
12457246162		16 mm	
12457252202		20 mm	
12457256202		20 mm	
12457259202		20 mm	

→ OD-Outer diameter → SW-Standard Wrench
→ ID-Inner diameter → R-Radius

INDUSTRIAL HOSE FITTINGS

Material: Nylon 66.
Colours: Blue or Gray.

Available in **PVDF** upon demand.
Colour: Natural.

 Working pressure: Up to 14 BAR (200 psi) at 20°C.

 Temperature: -20°C + 110°C (subject to application).
Assembly: Tubes dressed onto barbed tail of fitting and secured with Tefen snap clip (page 23).
Advantages: Strong and durable.
Uses: Fittings especially suitable for connecting plastic, rubber or soft p.v.c. hoses in industrial and domestic applications. As these hoses have various wall thicknesses the size is by ID measurement.

→ **FEMALE THREADED STRAIGHT HOSE CONNECTOR**

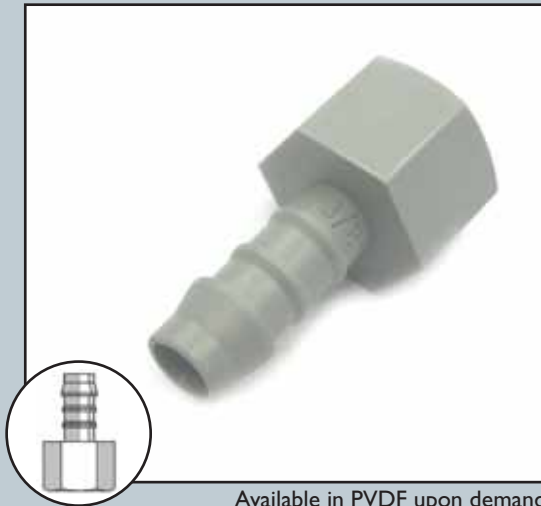

Available in PVDF upon demand

CAT. NO.	Hose ID	Thread BSPT	Color
I2446745028	5 mm	1/8"	
I2446745048	5 mm	1/4"	
I2446745068	5 mm	3/8"	
I2446745088	5 mm	1/2"	
I2446746028	6 mm	1/8"	
I2446746048	6 mm	1/4"	
I2446746068	6 mm	3/8"	
I2446746088	6 mm	1/2"	
I2446748028	8 mm	1/8"	
I2446748041	8 mm	1/4"	
I2446748048	8 mm	1/4"	
I2446748068	8 mm	3/8"	
I2446748088	8 mm	1/2"	
I2446750048	10 mm	1/4"	
I2446750068	10 mm	3/8"	
I2446750088	10 mm	1/2"	
I2446752048	12 mm	1/4"	
I2446752068	12 mm	3/8"	
I2446752088	12 mm	1/2"	
I2446754068	14 mm	3/8"	
I2446754088	14 mm	1/2"	
I2446756088	16 mm	1/2"	
I2446759088	19 mm	1/2"	

CAT. NO.	Hose ID	Thread NPT	Color
I2256704023	1/4"	1/8"	
I2256704043	1/4"	1/4"	
I2256704063	1/4"	3/8"	
I2256704083	1/4"	1/2"	
I2256705023	5/16"	1/8"	
I2256705043	5/16"	1/4"	
I2256705063	5/16"	3/8"	
I2256705083	5/16"	1/2"	
I2256706043	3/8"	1/4"	
I2256706063	3/8"	3/8"	
I2256706083	3/8"	1/2"	
I2256708043	1/2"	1/4"	
I2256708063	1/2"	3/8"	
I2256708083	1/2"	1/2"	
I2256709063	9/16"	3/8"	
I2256709083	9/16"	1/2"	
I2256710083	5/8"	1/2"	
I2256712083	3/4"	1/2"	

→ OD-Outer diameter → SW-Standard Wrench
→ ID-Inner diameter → R-Radius

→ MALE THREADED STRAIGHT HOSE CONNECTOR

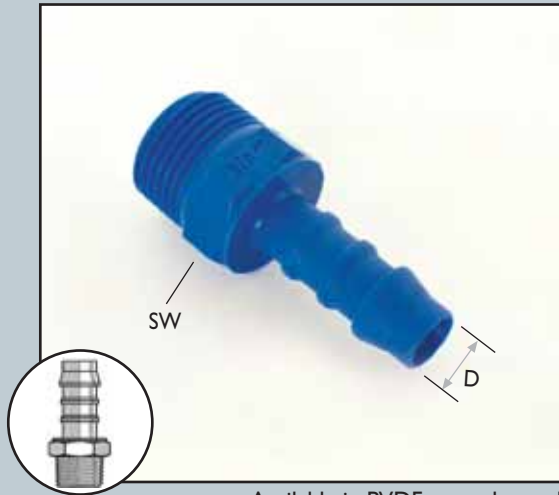

Available in PVDF upon demand

CAT. NO.	Hose I.D	Thread BSPT	SWmm	Color
12446844028	4 mm	1/8"	11	Blue
12446844048	4 mm	1/4"	14	Blue
12446845028	5 mm	1/8"	11	Blue
12446845048	5 mm	1/4"	14	Blue
12446846028	6 mm	1/8"	11	Blue
12446846048	6 mm	1/4"	14	Blue
12446846068	6 mm	3/8"	17	Blue
12446846088	6 mm	1/2"	22	Blue
12446846128	6 mm	3/4"	22	Blue
12446848028	8 mm	1/8"	11	Blue
12446848048	8 mm	1/4"	14	Blue
12446848068	8 mm	3/8"	17	Blue
12446848088	8 mm	1/2"	22	Blue
12446848128	8 mm	3/4"	17	Blue
12446850048	10 mm	1/4"	14	Blue
12446850068	10 mm	3/8"	17	Blue
12446850088	10 mm	1/2"	22	Blue
12446850128	10 mm	3/4"	27	Blue
12446852048	12 mm	1/4"	14	Blue
12446852068	12 mm	3/8"	17	Blue
12446852088	12 mm	1/2"	22	Blue
12446852128	12 mm	3/4"	27	Blue
12446854068	14 mm	3/8"	17	Blue
12446854088	14 mm	1/2"	22	Blue
12446854128	14 mm	3/4"	27	Blue
12446856088	16 mm	1/2"	22	Blue
12446856128	16 mm	3/4"	27	Blue
12446859088	19 mm	1/2"	22	Blue
12446859128	19 mm	3/4"	27	Blue
12446859168	19 mm	1"	36	Blue
12446865128	25 mm	3/4"	27	Blue
12446865168	25 mm	1"	36	Blue

→ SPECIAL PANEL MALE STRAIGHT HOSE CONNECTOR



Available in PVDF upon demand

CAT. NO.	D Hose I.D	Thread NPT	SW mm	Color
12256802023	5/32"	1/8"	11	Grey
12256802043	5/32"	1/4"	14	Grey
12256803023	3/16"	1/8"	11	Grey
12256803043	3/16"	1/4"	14	Grey
12256804023	1/4"	1/8"	17	Grey
12256804043	1/4"	1/4"	22	Grey
12256804063	1/4"	3/8"	11	Grey
12256804083	1/4"	1/2"	14	Grey
12256805023	5/16"	1/8"	17	Grey
12256805043	5/16"	1/4"	22	Grey
12256805063	5/16"	3/8"	14	Grey
12256805083	5/16"	1/2"	22	Grey
12256806043	3/8"	1/4"	22	Grey
12256806063	3/8"	3/8"	27	Grey
12256806083	3/8"	1/2"	22	Grey
12256806123	3/8"	3/4"	27	Grey
12256808043	1/2"	1/4"	22	Grey
12256808063	1/2"	3/8"	17.5	Grey
12256808083	1/2"	1/2"	27	Grey
12256808123	1/2"	3/4"	22	Grey
12256809063	9/16"	3/8"	27	Grey
12256809083	9/16"	1/2"	22	Grey
12256809123	9/16"	3/4"	27	Grey
12256810083	5/8"	1/2"	22	Grey
12256810123	5/8"	3/4"	27	Grey
12256812083	3/4"	1/2"	22	Grey
12256812123	3/4"	3/4"	27	Grey

→ FLANGE MOUNTING MALE STRAIGHT HOSE CONNECTOR

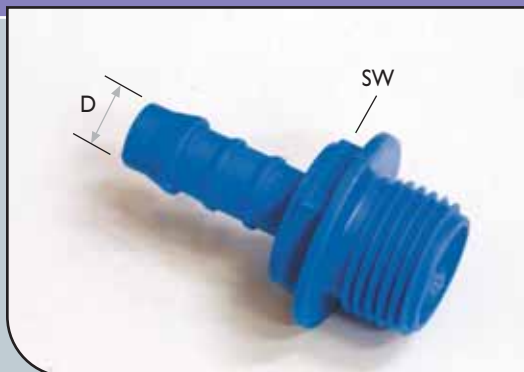

Available in PVDF upon demand

12P46850088	10 mm	1/2"	27	Blue
12P56806083	10 mm	1/2"	27	Grey
CAT. NO.	D Hose I.D	Thread BSPT	SW mm	Color
12F46850088	10 mm	1/2"	22	Blue

→ OD-Outer diameter → SW-Standard Wrench
→ ID-Inner diameter → R-Radius

→ MALE THREADED ELBOW HOSE CONNECTOR



Available in PVDF upon demand

CAT. NO.	D Hose I.D	Thread BSPT	SW mm	Color
I2446944028	4 mm	1/8"	11	
I2446944048	4 mm	1/4"	14	
I2446945028	5 mm	1/8"	11	
I2446945048	5 mm	1/4"	14	
I2446945088	5 mm	1/2"	22	
I2446946028	6 mm	1/8"	11	
I2446946048	6 mm	1/4"	14	
I2446946068	6 mm	3/8"	17	
I2446946088	6 mm	1/2"	22	
I2446948028	8 mm	1/8"	11	
I2446948048	8 mm	1/4"	14	
I2446948068	8 mm	3/8"	17	
I2446948088	8 mm	1/2"	22	
I2446950048	10 mm	1/4"	14	
I2446950068	10 mm	3/8"	17	
I2446950088	10 mm	1/2"	22	
I2446950128	10 mm	3/4"	27	
I2446952048	12 mm	1/4"	14	
I2446952068	12 mm	3/8"	17	
I2446952088	12 mm	1/2"	22	
I2446952128	12 mm	3/4"	27	
I2446954068	14 mm	3/8"	17	
I2446954088	14 mm	1/2"	22	
I2446954128	14 mm	3/4"	27	
I2446956088	16 mm	1/2"	22	
I2446956128	16 mm	3/4"	27	
I2446959088	19 mm	1/2"	22	
I2446959128	19 mm	3/4"	27	

CAT. NO.	D Hose I.D	Thread NPT	SW mm	Color
I2256902023	5/32"	1/8"	11	
I2256902043	5/32"	1/4"	14.5	
I2256903023	3/16"	1/8"	11	
I2256903043	3/16"	1/4"	14.5	
I2256903083	3/16"	1/2"	22	
I2256904023	1/4"	1/8"	11	
I2256904043	1/4"	1/4"	14.5	
I2256904063	1/4"	3/8"	18	
I2256904083	1/4"	1/2"	24	
I2256905023	5/16"	1/8"	11	
I2256905043	5/16"	1/4"	14.5	
I2256905063	5/16"	3/8"	18	
I2256905083	5/16"	1/2"	24	
I2256906043	3/8"	1/4"	14.5	
I2256906063	3/8"	3/8"	18	
I2256906083	3/8"	1/2"	24	
I2256906123	3/8"	3/4"	27	
I2256908043	1/2"	1/4"	14.5	
I2256908063	1/2"	3/8"	18	
I2256908083	1/2"	1/2"	24	
I2256908123	1/2"	3/4"	27	
I2256909063	9/16"	3/8"	18	
I2256909083	9/16"	1/2"	24	
I2256909123	9/16"	3/4"	27	
I2256910083	5/8"	1/2"	24	
I2256910123	5/8"	3/4"	27	
I2256912083	3/4"	1/2"	24	
I2256912123	3/4"	3/4"	27	

→ MALE THREADED ELBOW HOSE CONNECTOR - FLANGE



Available in PVDF upon demand

CAT. NO.	D Hose I.D	Thread BSPT	SW mm	Color
I2F46950068	10 mm	3/8"	17	
I2F46950088	10 mm	1/2"	22	

→ OD-Outer diameter → SW-Standard Wrench
→ ID-Inner diameter → R-Radius